

# Professional Luminaires



PRICE LIST w.e.f. 1<sup>st</sup> December 2011

**HAVELLS SYLVANIA Lumiance Concord**



# LUMINAIRES

## “FOCUSSED ON FUTURE TECHNOLOGIES”

Welcome to the first Havells-Sylvania Price List covering our three internationally recognised brands of Concord, Lumiance and Sylvania. Havells Sylvania is a leading full-spectrum provider of professional lighting solutions. Building on a Century of expertise in lamps and fixtures, Sylvania supplies state-of-the-art products and systems to the public, commercial and private sectors worldwide.

From fluorescent to CFL, from halogen to HID and beyond, Havells Sylvania strives to deliver the finest consulting, products and service available. All over the world, people rely on powerful brands like Concord, Lumiance, Sylvania and Havells for top quality, energy-efficient solutions to their individual lighting needs.

Formed in April 2007, Havells Sylvania is owned by Havells India Ltd. Havells is one of the largest and fastest growing manufacturers of electrical components and systems in India. With 94 branches and representative offices and 8,000 professionals in more than 50 countries, the group has grown rapidly to a 1 billion dollars company.

At 18 manufacturing plants in India, Europe, Latin America & Africa, the group produces globally acclaimed products such as switchgear, cables, wires, fixtures and lamps.

Backed by this global network of competence, Havells Sylvania is now in a stronger position than ever – and is poised to grow its market share significantly in years to come.

One thing you will certainly notice is the focus and growth in the number of exciting new products incorporating cutting-edge LED technology. Within the Concord range you will find the double award winning Stadium LED spotlight, independently judged to be the best LED spotlight on the market today. We have also introduced the new LED LED 150 an addition to the long standing LED 150 range which redefines the genre of low energy downlights with regards to efficiency and output.

From our Lumiance brand you will find the excellent Insaver range now with LED versions in both round and square form. These products provide great performance, crisp design and are readily available from any of our partner wholesale distributors. They are installer friendly provide simple and rapid installation and offer value for money, ideal for design and build applications and fast track projects.

Finally within our Sylvania product family we have introduced the RANA T5 recessed & linear fluorescent ranges both which incorporate our new COSS Louvre technology, providing excellent glare control with a world beating 90% efficacy providing optimum energy efficiency and meeting the growing demands of an ever increasing energy conscious world.

At Havells “we are focussed on future technologies to provide the most energy efficient lighting solutions”.

# GENERAL CONDITIONS OF BUSINESS

1. All prices are subject to Havells general terms & conditions of business.
2. This price list supercedes our earlier price list.
3. Prices are subject to change without notice.
4. All prices of luminaire included in the price list are without lamp/tube, except wherever specified otherwise.
5. Prices are inclusive of excise duty as prevailing on the date 1st March, 2011. Any statutory variation will be to purchaser's account.
6. Prices are exclusive of Sales Tax/VAT, local levies, Entry Tax, Toll Tax etc. These shall be charged extra.
7. As far as possible orders should be placed in case lot multiples.
8. All orders shall be placed in writing.
9. Continuous design improvement is a routine practice at Havells. Data provided may change without any prior intimation. Customers are advised to reconfirm the data or product dimensions before purchase with our local offices.

## content

Concord, Lumiance LED	1	-	4
Concord, Lumiance Spotlight	5	-	11
Concord, Sylvania Commercial	12	-	13
Concord, Sylvania Downlighter	14	-	15
Havells LED	16	-	18
Havells Commercial Lighting	19	-	23
Havells Downlighter	24	-	28
Havells Landscape/ Bunker Lighting	29	-	31
Havells Industrial Lighting	32	-	38
Havells Area Lighting	39	-	42
Havells Road Lighting	43	-	47
Havells Accessories	48	-	52
Phased out items	53	-	57



Concord was the original designer and manufacturer of architectural downlights and had a registered patent on the term “downlighter”, which lasted from 1966 to 2006.

Concord’s LED 150 was launched in 1996 and defined the term Low Energy Downlighter, specifically designed for the new energy saving TC-D and TC-T compact fluorescent lamps.

With over 40 years experience in downlighter technology, Concord introduces the NEW LEDLED 150, once again redefining the genre of Low Energy Downlights. LEDLED 150 provides a true economic and highly efficient replacement for existing CFL downlights offering unprecedented efficiency and unmatched luminous flux. The new LEDLED 150 incorporates new XP-G chip technology from CREE producing 130 lm/W combined with a die-cast aluminium turbo finned cooling heat sink for reduction in LED junction temperature ensuring maximum efficiency and output offering long life upto 50,000 hours at 70% luminous flux.

**LED LED 150**

LED LED 150 using new LED XP-G chip technology from CREE, with UGR < 19 for workplace applications and very low glare < 200 Cd/m<sup>2</sup>.

Lamp Type	Ordering Code	Optics	List Price Each (₹)
1x22W LED	<i>LDEBFQP6FA4W022</i>	Cone 85°	33110/-
1x32W LED	<i>LDEBFQP6FA4W032</i>	Cone 85°	33960/-

Ceiling cutout size Ø 176 mm, height 142 mm



**MYRIAD V RECESSED LED 15W 30° IP44 HOUSING\***

High efficiency IP44 LED downlight complete with LED driver & options for architectural accessories each providing a different lit dimension.

Lamp Type	Ordering Code	Optics	List Price Each (₹)
13W LED 3000K	<i>LDEBSPBFNN6W013</i>	Cone 29°	11500/-
13W LED 4000K	<i>LDEBSPGFBN6W013</i>	Cone 29°	11500/-
13W LED 5000K	<i>LDEBSPDFNN6W013</i>	Cone 29°	11500/-

Ceiling cutout size Ø 76 mm, height 72 mm



**MYRIAD V RECESSED LED 15W 30° IP65 HOUSING\***

High efficiency IP65 LED downlight in white bezel finish complete with LED driver & options for architectural accessories each providing a different lit dimension.

Lamp Type	Ordering Code	Optics	List Price Each (₹)
13W LED 3000K	<i>LDEBSPBFBN6W013</i>	Cone 30°	12000/-
13W LED 4000K	<i>LDEBSPGFBN6W013</i>	Cone 30°	12000/-
13W LED 5000K	<i>LDEBSPDFBN6W013</i>	Cone 30°	12000/-

Ceiling cutout size Ø 76 mm, height 72 mm



**\*ACCESSORIES FOR MYRIAD V RECESSED LED**

Kometa Ring		Bezel + Micro Glass Dish		Bezel + Floating Micro Glass Stack		Bezel + Blue Deep Ring		Bezel + Kick Deflector	
LDAEDZNBNNW000		LDAEDZNFNNW000		LDAEDZNCNNW000		LDAEDZNDNNW000		LDAEDZENNNW000	
									
Ord. Code	LP	Ord. Code	LP	Ord. Code	LP	Ord. Code	LP	Ord. Code	LP
<b>2049561</b>	3800/-	<b>2049563</b>	10000/-	<b>2049565</b>	4000/-	<b>2017370</b>	850/-	<b>2017398</b>	1650/-

Example: for Myriad V Recessed LED 15W 30° IP44 Housing  
Place order for - 2050661 + 2049561 (₹ 11324/- + ₹ 3737/-)

**MYRIAD V PENDANT RECESSED**

High efficiency LED pendant in silver finish with low power consumption of 15W complete with LED driver & remote gear.

Lamp Type	Ordering Code	Optics	List Price Each (₹)
13W LED 3000K	<i><b>LDEIFSPBJY1S013</b></i>	Cone 29°	14500/-
13W LED 4000K	<i><b>LDEIFSPGJY1S013</b></i>	Cone 29°	14500/-
13W LED 5000K	<i><b>LDEIFSPDJY1S013</b></i>	Cone 29°	14500/-

Note: Suspension wire included



**MYRIAD V PENDANT RECESSED**

High efficiency LED pendant in white finish with low power consumption of 15W complete with LED driver & remote gear.

Lamp Type	Ordering Code	Optics	List Price Each (₹)
13W LED 3000K	<i><b>LDEIFSPBJY1W013</b></i>	Cone 29°	14500/-
13W LED 4000K	<i><b>LDEIFSPGJY1W013</b></i>	Cone 29°	14500/-
13W LED 5000K	<i><b>LDEIFSPDJY1W013</b></i>	Cone 29°	14500/-

Note: Suspension wire included



**MYRIAD V PENDANT RECESSED**

High efficiency LED pendant in black finish with low power consumption of 15W complete with LED driver & remote gear.

Lamp Type	Ordering Code	Optics	List Price Each (₹)
13W LED 3000K	<i><b>LDEIFSPBJY1B013</b></i>	Cone 29°	14500/-
13W LED 4000K	<i><b>LDEIFSPGJY1B013</b></i>	Cone 29°	14500/-
13W LED 5000K	<i><b>LDEIFSPDJY1B013</b></i>	Cone 29°	14500/-

Note: Suspension wire included



**MYRIAD V PENDANT SURFACE MOUNTED**

High efficiency LED pendant in silver finish with low power consumption of 15W complete with LED driver & surface mounted polished chrome housing.

Lamp Type	Ordering Code	Optics	List Price Each (₹)
13W LED 3000K	<i><b>LDEIFSPGJN1S013</b></i>	Cone 29°	17500/-
13W LED 4000K	<i><b>LDEIFSPBJN1S013</b></i>	Cone 29°	17500/-
13W LED 5000K	<i><b>LDEIFSPDJN1S013</b></i>	Cone 29°	17500/-

Note: Suspension wire included



**MYRIAD V PENDANT SURFACE MOUNTED**

High efficiency LED pendant in white finish with low power consumption of 15W complete with LED driver & surface mounted polished white housing.

Lamp Type	Ordering Code	Optics	List Price Each (₹)
15W LED 3000K	<i><b>LDEIFSPBJN1W013</b></i>	Cone 29°	17500/-
15W LED 4000K	<i><b>LDEIFSPGJN1W013</b></i>	Cone 29°	17500/-
15W LED 5000K	<i><b>LDEIFSPDJN1W013</b></i>	Cone 29°	17500/-

Note: Suspension wire included



**MYRIAD V PENDANT SURFACE MOUNTED**

High efficiency LED pendant in black finish with low power consumption of 15W complete with LED driver & surface mounted polished black housing.

Lamp Type	Ordering Code	Optics	List Price Each (₹)
15W LED 3000K	<i><b>LDEIFSPBJN1B013</b></i>	Cone 29°	17500/-
15W LED 4000K	<i><b>LDEIFSPGJY1B013</b></i>	Cone 29°	17500/-
15W LED 5000K	<i><b>LDEIFSPDJN1B013</b></i>	Cone 29°	17500/-

Note: Suspension wire included



Note:  
Ordering Code in Bold & Italics indicates extended delivery period (8 to 10 weeks) Ex.: (LDEIFSPBJN1B013)



Insaver LED is a complete range of LED downlights designed for flexibility and practicality. Insaver LED offers 2 colour temperatures - warm white and neutral white, three different sizes in keeping with the Insaver HE range (75, 150, 175), and two heights.

Thanks to the innovative LED technology and temperature management, this line of products ensures not only very low power consumption of 17W-42W, but also an extremely long life of up to 50,000 hours. This makes Insaver LED the right solution for application areas with high switching frequency and low temperature.

The entire range is available with dimmable and non-dimmable LED drivers for push button and 1-10V standard versions as well as Dali, Emergency and Dali Emergency variations. Insaver LED range also offers a wide array of accessories including IP44 clear glass, decorative bezel, floating glass and mounting plate for soft ceilings (150 & 175).

Insaver LED 150/175 are both offered in two versions, one offers excellent glare control (UGR <19) that ensures high visual performance in office spaces, the second offers recess depth below 100mm.

At a glance, Insaver LED suits in a wide variety of applications. It is the perfect solution for supplying efficient, pleasant lighting in offices, hotels, residential, and covered outdoor spaces, with efficacy up to 66lm/W.

#### INSAVER 75 LED 16W ROUND

Recess mounted IP65 LED fitting in white bezel finish & round profile with thermal management to ensure life upto 50,000 hrs. supplied with electronic driver.

Lamp Type	Ordering Code	Optics	List Price Each (₹)
16W LED 3000K	<i>LUEBAVPBFN6W016</i>	Cone 54°	7500/-
16W LED 4000K	<i>LUEBAVPDFN6W016</i>	Cone 54°	7500/-

Ceiling cutout size Ø 75 mm, height 65 mm



#### INSAVER 75 LED 16W SQUARE

Recess mounted IP65 LED fitting in white bezel finish & square profile with thermal management to ensure life upto 50,000 hrs. supplied with electronic driver.

Lamp Type	Ordering Code	Optics	List Price Each (₹)
16W LED 3000K	<i>LUEBAVPBFQ6W016</i>	Cone 35°	8500/-
16W LED 4000K	<i>LUEBAVPDFQ6W016</i>	Cone 35°	8500/-

Ceiling cutout size 75x75 sq. mm, height 65 mm



#### INSAVER 150 LED 16W ROUND

Recess mounted LED fitting with low power consumption of 16W & scratch-proof anti glare reflector supplied with electronic driver.

Lamp Type	Ordering Code	Optics	List Price Each (₹)
16W LED 3000K	<i>LUEBAWPBFN6W016</i>	Cone 92°	12650/-
16W LED 4000K	<i>LUEBAWPDFN6W016</i>	Cone 92°	12650/-

Ceiling cutout size Ø 152 mm, height 100 mm



#### INSAVER 150 LED 35W ROUND

Recess mounted LED fitting with low power consumption of 35W & scratch-proof anti glare reflector supplied with electronic driver.

Lamp Type	Ordering Code	Optics	List Price Each (₹)
35W LED 3000K	<i>LUEBAWPBFN6W035</i>	Cone 93°	14100/-
35W LED 4000K	<i>LUEBAWPDFN6W035</i>	Cone 93°	14100/-

Ceiling cutout size Ø 152 mm, height 100 mm



**INSAVER 175 LED 46W ROUND**

Recess mounted LED fitting with low power consumption of 46W & scratch-proof anti glare reflector supplied with electronic driver.

Lamp Type	Ordering Code	Optics	List Price Each (₹)
46W LED 3000K	<i><b>LUEBAXPBFN6W046</b></i>	Cone 102°	18550/-
46W LED 4000K	<i><b>LUEBAXPDFN6W046</b></i>	Cone 102°	18550/-

Ceiling cutout size Ø 178 mm, height 100 mm

**LUMIANCE MOTTO LED SQUARE**

Low energy consuming Motto LED Square, shock and vibration resistant with high colour saturation

Ceiling Plate



Lamp Unit



Lumi Driver



Lumi Splitter



Ord. Code	Description	Colour	LP Each (₹)
<b>Ceiling Plate</b>			
LU3036111	Motto LED Ceiling Plate Mono	Brushed Aluminium	2460/-
LU3036112	Motto LED Ceiling Plate Duo	Brushed Aluminium	4800/-
LU3036113	Motto LED Ceiling Plate Trio	Brushed Aluminium	7150/-
LU3036118	Motto LED Square Plate	Brushed Aluminium	9260/-
<b>Lampunit</b>			
LU3036161	Motto LED Lampunit 1W Cool White	Cool White	1430/-
LU3036166	Motto LED Lampunit 1W Warm White	Warm White	1430/-
LY3036171	Motto LED Lampunit 3W Cool White	Cool White	3000/-
LY3036176	Motto LED Lampunit 3W Warm White	Warm White	3000/-
LU3036181	Motto LED Lampunit 1W Blue	Blue	1430/-
LU3036191	Motto LED Lampunit 3W Blue	Blue	3000/-
<b>Lumidriver</b>			
LU3036200	Lumidriver LED 6x1W	-	2210/-
LY3036201	Lumidriver LED 3x3W	-	3610/-
<b>Lumisplitter</b>			
LU3036202	Lumisplitter 6x1W	-	425/-
LY3036203	Lumisplitter 3x3W	-	425/-

Example: for Motto LED ceiling plate mono

Place order for - LU3036111 + LU3036161 + LU3036200 + LU3036202 (₹ 2460/- + ₹ 1430/- + ₹ 2210/- + ₹ 425/-)

Note:

Ordering Code in Bold & Italics indicates extended delivery period (8 to 10 weeks) Ex.: (LUEBAVPBFN6W016)

# CONCORD SPOTLIGHT



## STADIUM EVO LED SPOTLIGHT

High output LED spotlight in compact slim design with high inrush current protection & excellent colour rendering. Ideal for accent lighting.

Lamp Type	Ordering Code	Optics	List Price Each (₹)
16x1W LED 3000K	LY2046395	Cone 25°	26420/-
16x1W LED 4000K	LY2046407	Cone 25°	26420/-
16x1W LED 6000K	LY2046383	Cone 10°	26420/-
16x1W LED 3000K	LDFARP5PNBS025*	Cone 10°	26620/-
16x1W LED 3000K	LDFATP5PNBS025*	Cone 25°	26620/-

\* Suitable for three circuit track. Order suitable track.

## STADIUM PRO LED SPOTLIGHT

High output dimmable LED three circuit spotlight individually dimmable using on-board dimmer 0-100% current control facility for over temperature protection.

Lamp Type	Ordering Code	Optics	List Price Each (₹)
16x1W LED 3000K	LDFFAUP5PNBS023	Cone 25°	32560/-
16x1W LED 4000K	LDFFAUP6PNBS023	Cone 25°	32560/-

Order suitable track.

## BEACON LED - SPOT (NARROW BEAM)

Beacon LED Spot, high efficiency LED spotlight range, contemporary all die-cast design, cooling fin design to maximise thermal management. Available in single circuit and three circuit option.

Lamp Type	Ordering Code	Optics	List Price Each (₹)
Beacon LED Spot (Single Circuit)			
13x1W LED 3000K	LDEEGMPBNNAW013 (white)	Cone 15°	18300/-
13x1W LED 4000K	LDEEGMPDNNAW013 (white)	Cone 15°	18300/-
Beacon LED Spot (Three Circuit)			
13x1W LED 3000K	LDEEGMPBNNBW013 (white)	Cone 15°	17890/-
13x1W LED 4000K	LDEEGMPDNNBW013 (white)	Cone 15°	17890/-

Note: Silver and Black colour option are available on request. Order suitable track.

## BEACON LED - SPOT (FLOOD)

Beacon LED Spot, high efficiency LED spotlight range, contemporary all die-cast design, cooling fin design to maximise thermal management. Available in single circuit and three circuit option.

Lamp Type	Ordering Code	Optics	List Price Each (₹)
Beacon LED Spot (Single Circuit)			
13x1W LED 3000K	LDEEGNPBNNAW013 (white)	Cone 30°	17950/-
13x1W LED 4000K	LDEEGNPDNNAW013 (white)	Cone 30°	17950/-
Beacon LED Spot (Three Circuit)			
13x1W LED 3000K	LDEEGNPBNNBW013 (white)	Cone 30°	17500/-
13x1W LED 4000K	LDEEGNPDNNBW013 (white)	Cone 30°	17500/-

Note: Silver and Black colour option are available on request. Order suitable track.

## ACCESSORIES FOR BEACON LED SPOT

	Ordering Code	List Price Each (₹)
Beacon LED Coloured Gel Pack	LDAEGMNENN6W000	670/-
Beacon Flood Lense (To give 40° beam)	LDAEGMNNFI6W000	1120/-





**TORUS 50FX LOW VOLTAGE**

Torus 50FX single circuit spot lights in white & silver finish and integral electronic gear for 12V-50W low voltage tungsten halogen capsule lamps with 10° spot & 25° flood.

Lamp Type	Ordering Code	Optics	List Price Each (₹)
QT12-LPax 50W	LD2028550 (white)	Cone 10°	9290/-
	LY2028555 (silver)	Cone 10°	9280/-
	LY2028570 (silver)	Cone 25°	9260/-
	LY2028565 (white)	Cone 25°	9090/-

Order lamp separately. Order suitable track/mono point.

**TORUS 50 LOW VOLTAGE**

Torus 50 lightweight single circuit spot lights in white & silver finish with 150 mm depth & integral electronic gear for 12V-50W dichroic lamps with 10° spot & 38° flood.

Lamp Type	Ordering Code	Optics	List Price Each (₹)
QR-CBC51 50W	LD2025729 (white)	Cone 10°/38°	7690/-
	LY2025734 (silver)	Cone 10°/38°	7680/-

Order lamp separately. Order suitable track/mono point.

**TORUS 35/70FX CMI-TC**

Torus 35/70FX single circuit in white & silver finish with lightweight integrated electronic control gear and flicker free operation with 10°/11° spot & 37°/39° flood.

Lamp Type	Ordering Code	Optics	List Price Each (₹)
CMI-TC 35W	LY2031840 (silver)	Cone 10°	12080/-
	LD2031848 (white)	Cone 37°	11080/-
	LY2031853 (silver)	Cone 37°	10900/-
	LY2031835 (white)	Cone 10°	10950/-
CMI-TC 70W	LD2029073 (white)	Cone 39°	12080/-
	LY2029058 (white)	Cone 11°	12120/-

Order lamp separately. Order suitable track/mono point.

**TORUS BRITESPOT 111 SPOTLIGHT**

Torus BriteSpot 111 light & compact single circuit spotlight in white finish integrated with gear.

Lamp Type	Ordering Code	Optics	List Price Each (₹)
BriteSpot ES111 35W	LY2037413	Cone 24°	11190/-

Order suitable track/mono point.  
Supplied with 35W 24° BriteSpot ES111 high output lamp.

**TORUS 100FX LOW VOLTAGE**

Torus 100FX compact single circuit spotlight in silver & white finish supplied with Sylvania 100W axial filament lamp with integral transformer.

Lamp Type	Ordering Code	Optics	List Price Each (₹)
QT12-LPax 100W	LY2040754 (white)	Cone 8-12° Spot	10870/-
	LY2040755 (silver)	Cone 8-12° Spot	10870/-
	LY2040760 (white)	Cone 8-14° Spot	11420/-
	LY2040761 (silver)	Cone 8-14° Spot	11420/-
	LY2040766 (white)	34° Flood	11240/-

Order lamp separately. Order suitable track/mono point.

**TORUS BRITESPOT 50 METAL HALIDE**

Torus BriteSpot 50 high output single circuit spotlight in silver & white finish with lamp grip for easy replacement of lamp.

Lamp Type	Ordering Code	Optics	List Price Each (₹)
BriteSpot ES50 35W	LY2034994 (silver)	Cone 38°	12630/-
	LD2034990 (white)	Cone 38°	12700/-

Order suitable track/mono point. Supplied with Sylvania 35W 38° BriteSpot ES50 lamp.



# CONCORD SPOTLIGHT

## TORUS 35/70FX CMI-T

Torus 35/70FX single circuit compact spotlight in silver & white finish integrated with lightweight electronic control gear.

Lamp Type	Ordering Code	Optics	List Price Each (₹)
CMI-T 35W	LY2035032 (white)	Cone 11°	10250/-
	LY2035035 (silver)	Cone 11°	10260/-
	LY2035042 (white)	Cone 28°	10410/-
	LY2035045 (silver)	Cone 28°	10330/-
CMI-T 70W	LY2036383 (silver)	Cone 29°	10630/-
	LY2036370 (white)	Cone 12°	10470/-
	LY2036373 (silver)	Cone 12°	10430/-
	LY2036380 (white)	Cone 29°	10630/-

Order lamp separately. Order suitable track/mono point.

## CONCORD BEACON MAINS VOLTAGE

Beacon mains voltage light weight single circuit spotlight. Slim all die-cast compact design with 50W halogen without need of transformer.

Lamp Type	Ordering Code	Optics	List Price Each (₹)
QPAR50 50W	LD2041879	Cone 25°/50°	2150/-

Order lamp separately. Order suitable track/mono point.

## CONCORD BEACON LOW VOLTAGE

Beacon low voltage light weight spotlight. All die-cast design for 12V - 50W dichroic lamp with compact electronic transformer both in white & silver finish.

Lamp Type	Ordering Code	Optics	List Price Each (₹)
QR-CB51 50W	LY2041898 (silver)	Cone 10°/38°	6180/-
	LD2041897 (white)	Cone 10°/38°	6180/-

Order lamp separately. Order suitable track/mono point.

## CONCORD BEACON BRITESPOT ES50

Beacon BriteSpot Spotlight with quartz metal halide reflector lamp technology for excellent colour rendering.

Lamp Type	Ordering Code	Optics	List Price Each (₹)
BriteSpot ES50 35W	LY2041904 (silver)	Cone 60°/38°	8420/-
	LD2041903 (white)	Cone 60°/38°	8420/-
	LY2041906 (white)*	Cone 60°/38°	8630/-

\* Suitable for three circuit track.

Order lamp separately. Order suitable track/mono point.

## CONCORD BEACON CMI/ CDM-T 35W/ 70W

Beacon CMI/ CDM-T single circuit spotlight in silver & white finish with spot or flood safety lense.

Lamp Type	Ordering Code	Optics	List Price Each (₹)
CMI-T 35W	LY2046413 (silver)	Cone 13°	10520/-
	LY2046412 (white)	Cone 13°	10500/-
	LY2046416 (silver)	Cone 34°	10590/-
	LY2046415 (white)	Cone 34°	10570/-
	LY2041910 (silver)	Cone upto 34°	10200/-
	LY2041909 (white)	Cone upto 34°	10190/-
CMI-T 70W	LY2046425 (silver)	Cone 15°	10660/-
	LY2046424 (white)	Cone 15°	10640/-
	LY2046428 (silver)	Cone 35°	10730/-
	LY2046427 (white)	Cone 35°	10710/-
	LY2041916 (silver)	Cone upto 35°	10780/-
	LY2041915 (white)	Cone upto 35°	10330/-

Order lamp separately. Order suitable track/mono point.

## CONCORD LYESPAN: SINGLE CIRCUIT TRACK SYSTEM

Slim, broad based, low profile single circuit track for surface mounting, onto walls, ceiling or floors.

Length	Ordering Code	List Price Each (₹)
1m	LD2019502 (white)	2950/-
2m	LD2019503 (white)	3820/-

Note: Silver and Black colour option are available on request.



**CONCORD LYESPAN 3: THREE CIRCUIT TRACK SYSTEM**

Slim, broad based, low profile three circuit track for surface mounting, onto walls, ceiling or floors.

Length	Ordering Code	List Price Each (₹)
1m	LDAGAHN1BNBW000 (white)	3270/-
2m	LDAGAHN2BNBW000 (white)	4920/-

Note: Silver and Black colour option are available on request.



**ACCESSORIES**

**PUSH-UP LIVE FEED**

Push-Up Live Feed: Feeds power on or off anywhere along length of track.

Description	Ordering Code	List Price Each (₹)
Left	LY2027546 (white)	2790/-
Right	LY2027549 (white)	2520/-
Universal	LDAGAKNNBNBW000 (white)	2868/-

Note: Silver and Black colour option are available on request.

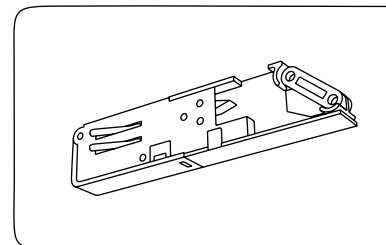

**STRAIGHT PLUG-IN COUPLER**

Straight Plug-in Coupler: Connects tracks to create straight runs.

Description	Ordering Code	List Price Each (₹)
Mechanical/Electrical	LY2020797 (white)	1250/-

Note: Silver and Black colour option are available on request.

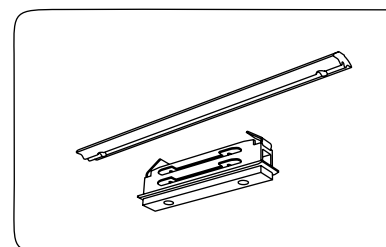

**L COUPLER**

L Coupler: Polarised couplers supplied pre-wired for ease of installation.

Description	Ordering Code	List Price Each (₹)
Inside	LDAGANNNHNBW000 (white)	5320/-
Outside	LDAGANNINNBW000 (white)	6462/-

Note: Silver and Black colour option are available on request.

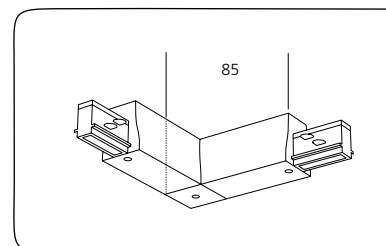

**T COUPLER**

T Coupler: Polarised couplers supplied pre-wired for ease of installation.

Description	Ordering Code	List Price Each (₹)
Left	LDAGANNNFNBW000 (white)	8279/-
Right	LDAGANNNGNBW000 (white)	8800/-

Note: Silver and Black colour option are available on request.

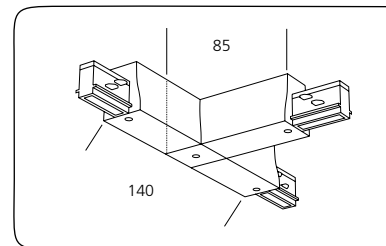

**X COUPLER**

X Coupler: Polarised couplers supplied pre-wired for ease of installation.

Description	Ordering Code	List Price Each (₹)
Universal	LDAGANNJNBW000 (white)	10838/-

Note: Silver and Black colour option are available on request.

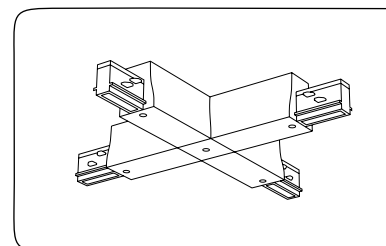

## FLEXIBLE COUPLER

Flexible Coupler: Close to a minimum of 45 horizontally, can be easily removed to mechanical only.

Description	Ordering Code	List Price Each (₹)
Mechanical/Electrical	LY2020798 (white)	12390/-

Note: Silver and Black colour option are available on request.

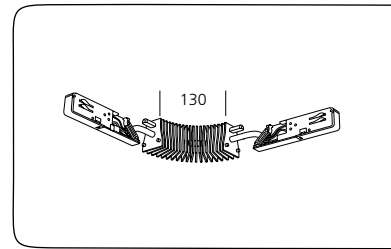

## END CAP

End cap: Must be used to safely terminate track ends on both side.

Description	Ordering Code	List Price Each (₹)
Caps to terminates ends	LY2020789 (white)	170/-

Note: Silver and Black colour option are available on request.

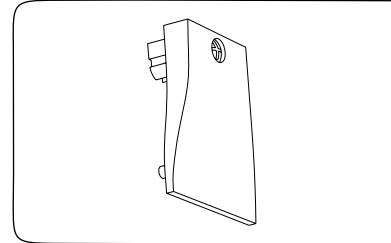

## MONO POINT

Mono point for surface mounting of single or three circuit track adapters order onto ceiling or walls.

Description	Ordering Code	List Price Each (₹)
Mono Point Single Circuit	<b><i>LU3020060</i></b> (white)	540/-
Mono Point Three Circuit	<b><i>LDAGAENNNNNW000</i></b> (white)	1057/-

Note: Silver and Black colour option are available on request.



Note:  
Ordering Code in Bold & Italics indicates extended delivery period (8 to 10 weeks) Ex.: (LDEEGMPBNNAW013)

# LUMIANCE SPOTLIGHT

# LUMIANCE SPOTLIGHT

# LUMIANCE SPOTLIGHT

# LUMIANCE SPOTLIGHT



## LUMIANCE SIGNO 115

Signo 115 adjustable downlights, 60° tilt & 355° rotation, unique friction system inside housing for optimal adjustment.

Lamp Type	Ordering Code	Optics	List Price Each (₹)
QPAR64 75W	LU3020350 (white)	Cone 25°	3190/-
QR-CB51 50W	LU3020360 (white)	Cone 10°/38°	2030/-
Britespot ES50 35W**	LU3021560 (white)	Cone 38°	6370/-

\*\* Supplied with Britespot ES50 35W 38° lamp  
Ceiling cutout size Ø 115 mm, height 115 mm  
Order Transformer/ CMI Britetronic ballast separately



## LUMIANCE SIGNO 155

Signo 155 adjustable downlights, 60° tilt & 355° rotation, quick fix springs in solid die-cast aluminium housing.

Lamp Type	Ordering Code	Optics	List Price Each (₹)
Q-PAR30 100W	LU3020690 (white)	Cone 30°/10°	2750/-
QT-ax12 100W	LU3020430 (white)	Non-Category	3090/-
CMI-T 35/70W	LU3021260 (white)	Non-Category	3730/-

Ceiling cutout size Ø 155 mm, height 120 mm  
Order Transformer/ CMI Britetronic ballast separately



## LUMIANCE SIGNO 205

Signo 205 CMI-T flood downlight with easy mounting 60° tilt & 355° rotation.

Lamp Type	Ordering Code	Optics	List Price Each (₹)
CMI-T 35/70/150W	LU3000880 (white)	Non-Category	5190/-

Ceiling cutout size Ø 205 mm, height 170 mm  
Order CMI ballast separately



## LUMIANCE SIGNO 205 (FIXED)

Signo 205 fixed spotlight in solid die-cast aluminium housing.

Lamp Type	Ordering Code	Optics	List Price Each (₹)
CMI-T 35/70/150W	LU3000810 (white)	Non-Category	3990/-

Ceiling cutout size Ø 155 mm, height 120 mm  
Order CMI ballast separately



## LUMIANCE MOTTO 82

Motto 82 downlight with low recess depth of 100 mm in 60° & 38° options.

Lamp Type	Ordering Code	Optics	List Price Each (₹)
Britespot ES50 35W	LUEFCGMBON1W035 (white)*	Cone 60°	5810/-
	LU3035061 (white)**	Cone 38°	5810/-

\* Supplied with Britespot ES50 35W 60° lamp  
\*\* Supplied with Britespot ES50 35W 38° lamp  
Ceiling cutout size Ø 82 mm, height 100 mm  
Order appropriate CMI Britetronic ballast separately



## TRANSFORMER, CONTROL GEAR HALOGEN TRANSFORMER

Lamp Type	Ordering Code	List Price Each (₹)
For 12V/50W Halogen	LYGTAHANNQN1050	450/-
For 12V/100W Halogen	LYGTBHANNQN2105	725/-
For 12V/150W Halogen	LYGTCHANNQN3150	940/-

## MH/CMI CONTROL GEAR

Lamp Type	Ordering Code	List Price Each (₹)
1x35W CMI	LYGEIE151035	2755/-
1x70W CMI	LYGEIE151070	2755/-
1x150W CMI	LYGEIE151150	4620/-

## BRITETRONIC CMI BALLAST

Lamp Type	Ordering Code	List Price Each (₹)
For BriteSpot Lamps 35W/70W	LY0010913	3500/-





Office lighting has progressed considerably since the endless banks of fluorescent fittings, strictly arranged in line formation, seen in the office design from the late 20th Century.

Partitions have fallen, risen and fallen over the years, furniture has become more ergonomic, particular needs and functions better defined, evolving into the current, more considered workspace where individuality and flexibility reflect the fluidity of technology and changing working practices. Employers have begun to realise that their staff are their most precious resource and that the quality of the working environment has a huge impact not only on attracting and retaining staff, but on increasing productivity and reducing absenteeism.

The quality of light output from a fitting should always transcend its aesthetic appeal, but as the trend moves to a greater integration of lighting into the architectural structure, lighting systems themselves have become more lithe, streamlined and discreet, largely thanks to the development of the slimline T5 tube. The powerful output of the T5, tempered by sophisticated optics, allow a more even washing of both horizontal and vertical surfaces.

The recognition that colour temperature and the dynamics of the lighting system have a profound effect on the health, well-being and productivity of employees is also leading to further crucial improvements. Human beings evolved in daylight, and the cool colour temperatures and mercurial quality of natural light have left their imprint.

The discovery in 2002 of a third photoreceptor in the eye (other than rods and cones) has been central to thinking in this area. This photoreceptor allows light to bypass the visual system and for signals on light levels and colour temperature to be sent direct to the pineal gland in our brain, which governs our circadian rhythms, or sleep-wake cycle.

The realisation that human beings function better under daylight conditions has led to a greater drive to improve the ingress of natural light into new buildings, in conjunction with more advanced solar and daylight-linked control systems. However, there are a variety of scenarios – older buildings, deep-plan designs, 24-hour working environments – where employees are cut off from daylight for extensive periods.

This has led first to a rethinking on the trend in past years towards warmer white fluorescent, with a growing emphasis now on cooler, daylight temperatures, even to the degree of adding more blue to the mix which limited studies have shown increases alertness and productivity among employees.

But probably one of the most exciting developments in office lighting in recent years has been the emergence of daylight-simulation systems. Using a control system, different temperature white fluorescent tubes, or in some cases, red, green and blue (RGB) systems, combine at varying levels of output to change the lighting from cool to warm white throughout the course of the day, reflecting the changing quality of daylight outside.

With its varied meeting rooms, cafes, break-out areas and hot-desking spaces, the contemporary workspace couldn't be further from the gloomy late 20th Century office environment. Today lighting is a key tool in helping to delineate different areas and to define individuality.

**CONCORD OFFICELYTE CONCAVE**

Innovative modular recess fitting, conical de-glaring prism center panel, quick & simple installation.

Lamp Type	Ordering Code	Optics	List Price Each (₹)
2x24W T5	LY2047219	Diffused	18000/-

Ceiling cutout size 595x595 mm



**CONCORD OFFICELYTE**

Innovative modular recess fitting, LG7 compliant fixture with elegant satin prismatic wings & conical de-glaring prism center panel.

Lamp Type	Ordering Code	Optics	List Price Each (₹)
1x55W TC-L	LD2037296	Diffused	14000/-
2x24W TC-L	LD2038964	Diffused	14000/-

Ceiling cutout size 595x595 mm



**CONCORD KOMETA 600**

Recess circular model in 600x600 luminaire combines ambient light effect with efficient down light, independent switching option available.

Lamp Type	Ordering Code	Optics	List Price Each (₹)
TC-TEL 26W/32W/T16-R 40W	LD4064670 (smooth)	Direct-Indirect	18000/-

Ceiling cutout size 595/595 mm



**CONCORD KOMETA 300**

Recess circular model combines ambient light effect with efficient down light, independent switching option available.

Lamp Type	Ordering Code	Optics	List Price Each (₹)
TC-TEL 26W/ T16-R 22W	LD2037420 (single switched) LD2037422 (twin switched)	Direct-Indirect Direct-Indirect	12000/- 14500/-

Ceiling cutout size Ø 275 mm, height 146 mm



**EQUILIBRO BESS 4**

Recessed mounted with direct & indirect fixture with specular Bess 4 high performance aluminium louvre. Anti. glare for visual comfort.

Lamp Type	Ordering Code	Optics	List Price Each (₹)
2x24W T5	LY0058870	Direct Cat. 2 louvre Indirect by wing	6000/-

Ceiling cutout size 595x595 mm



**RANA RECESS**

Recess mounted with sleek design (46 mm depth) & easy installation. Revolutionary COSS louvre technology ensures world beating 92% light output ratio and upto 40% energy saving.

Lamp Type	Ordering Code	Optics	List Price Each (₹)
3x14W T5 4000K	LY0049720	1092 louvre Cat.2	8000/-

Ceiling cutout size 595x595 mm

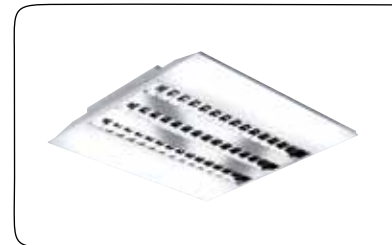

**RANA RECESS**

Recess mounted with sleek design (46 mm depth) & easy installation. Revolutionary COSS louvre technology ensures world beating 92% light output ratio and upto 40% energy saving.

Lamp Type	Ordering Code	Optics	List Price Each (₹)
4x14W T5 4000K	LY0049700	1092 louvre Cat.2	8500/-
4x24W T5 4000K	LY0049776	1092 louvre Cat.2	9000/-

Ceiling cutout size 595x595 mm



**RANA RECESS**

Recess mounted with sleek design (46 mm depth) & easy installation. Revolutionary COSS louvre technology ensures world beating 92% light output ratio and upto 40% energy saving.

Lamp Type	Ordering Code	Optics	List Price Each (₹)
2x28W T5 3000K	LY0049830	1092 louvre Cat.2	13060/-
2x28W T5 4000K	LY0049740	1092 louvre Cat.2	13060/-

Ceiling cutout size 295x1195 mm



**RANA SURFACE/ SUSPENDED**

Recess mounted with sleek design (47 mm height) & easy installation with invisible linear inter connection system. Revolutionary COSS louvre technology ensures world beating 92% light output ratio and upto 40% energy saving, available in direct-indirect modules.

Lamp Type	Ordering Code	Optics	List Price Each (₹)
2x28W T5 4000K	LY0050265	1092 louvre Cat.2 direct	9000/-
2x28W T5 4000K	LY0050259	1092 louvre Cat.2 direct-indirect	8800/-







**CONCORD LED 150-TE II**

LED 150 with slim line ceiling trim of only 11 mm, light out ratio upto 79%, integral gear box.

Lamp Type	Ordering Code	Optics	List Price Each (₹)
TC-TEL/ DEL 2x18W (4 Pin)	LD2038698	General Spread	8050/-
TC-TEL 2x26W (4 Pin)	LD2038701	General Spread	7950/-
TC-TEL/ DEL 2x32W (4 Pin)	LD2038703	General Spread	8390/-
TC-TEL/ DEL 2x42W (4 Pin)	LD2038705	General Spread	8700/-

Ceiling cutout size Ø 204 mm, height 156 mm.

**CONCORD LED 150-TE II**

LED 150 Wall Washer specular smooth reflector for even ceiling to wall illumination.

Lamp Type	Ordering Code	Optics	List Price Each (₹)
TC-TEL 2x18W (4 Pin)	LD2038751	General Spread	10240/-

Ceiling cutout size Ø 204 mm, height 180 mm.

**INSAVER 175 HE\***

Insaver 175 HE downlighters with electronic ballast, low recess depth, scratch proof polycarbonate reflector, extensive choice of accessories.

Lamp Type	Ordering Code	Optics	List Price Each (₹)
TC-DEL 1x18W (4 Pin)	LU3025860	General Spread	3420/-
TC-DEL 1x26W (4 Pin)	LU3025910	General Spread	3780/-

Ceiling cutout size Ø 178 mm, height 115 mm.

**INSAVER 175 HE CONE\***

Insaver 175 HE Cone scraper resistant reflector with floating fresnel diffuser.

Lamp Type	Ordering Code	Optics	List Price Each (₹)
TC-DEL 1x18W (4 Pin)	LU3033080	General Spread	3490/-
TC-DEL 1x26W	LU3033130	General Spread	3950/-

Ceiling cutout size Ø 178 mm, height 115 mm.

**INSAVER 175 HE TOPPER\***

Insaver 175 HE Topper, ideal for humid areas, uniform light distribution with opal diffuser.

Lamp Type	Ordering Code	Optics	List Price Each (₹)
TC-DEL 1x18W (4 Pin)	LU3033580	Diffused Spread	3310/-
TC-DEL 1x26W (4 Pin)	LY3033630	Diffused Spread	3670/-

Ceiling cutout size Ø 178 mm, height 115 mm.

**\*ACCESSORIES FOR HE 175 OPEN**

Clear Glass Cover (IP44)



ETCHED Decorative Glass Cover (IP44)



Deco Trim



Ord. Code	LP	Ord. Code	LP	Ord. Code	LP
LY3006920	670/-	LY3006950	720/-	LY3005960	220/-

Example: for Insaver 175 HE 1x18W  
Place order for - LU3025860 + LY3006920 (₹ 3420/- + ₹ 670/-)



# SYLVANIA DOWNLIGHTER

## INSAVER 225 HE

Insaver 225 HE open downlighter, high output ratio upto 71%, scartch resistant reflector with extensive choice of accessories.

Lamp Type	Ordering Code	Optics	List Price Each (₹)
TC-DEL 2x18W (4 Pin)	LU3029570	General Spread	4660/-
TC-DEL 2x26W (4 Pin)	LU3029580	General Spread	4770/-

Ceiling cutout size Ø 228 mm, height 120 mm.



## INSAVER 225 HE CONE

Insaver 225 HE Cone scraper resistant reflector with floating fresnel diffuser.

Lamp Type	Ordering Code	Optics	List Price Each (₹)
TC-DEL 1x18W (4 Pin)	LU3033180	General Spread	4810/-
TC-DEL 1x26W (4 Pin)	LU3033230	General Spread	4920/-

Ceiling cutout size Ø 228 mm, height 120 mm.



## INSAVER 225 HE TOPPER

Insaver 225 HE Topper, ideal for numrid areas, uniform light distribution with opal diffuser.

Lamp Type	Ordering Code	Optics	List Price Each (₹)
TC-DEL 2x26W (4 Pin)	LU3033780	Diffused Spread	4360/-

Ceiling cutout size Ø 228 mm, height 120 mm.



## \*ACCESSORIES FOR HE 225 OPEN

Decorative Glass

**LUABAEHVNN4N000**



Deco Trim



Deco Trim Square



Floating Glass

LUABAENNDNNN000



Ord. Code	LP	Ord. Code	LP	Ord. Code	LP	Ord. Code	LP
<b>3005710</b>	830/-	LU3005980	310/-	LU3005984	420/-	3005570	1070/-

Example: for Insaver 225 HE 2x18W

Place order for - LU3029570 + LUABAEHVNN4N000 (₹ 4660/- + ₹ 830/-)

## INSAVER 225 HE WALL WASHER

Insaver 225 HE Wall Washer optimized reflector for even ceiling to wall illumination.

Lamp Type	Ordering Code	Optics	List Price Each (₹)
TC-DEL 1x26W (4 Pin)	LU3033230	General Spread	4920/-

Ceiling cutout size Ø 228 mm, height 200 mm.



## INSAVER SYL-LIGHTER

Low recess depth, quick & easy to install, ideal for humid areas.

Lamp Type	Ordering Code	Optics	List Price Each (₹)
TC-DEL 1x18W (4 Pin)	LUFBEZH1PB4W018	Diffused Spread	2550/-
TC-DEL 1x26W (4 Pin)	LUFBEZH1PB4W026	Diffused Spread	2560/-
TC-DEL 2x18W (4 Pin)	LUFBEZH2PB4W018	Diffused Spread	2550/-
TC-DEL 2x26W (4 Pin)	LU3031530	Diffused Spread	2560/-

Ceiling cutout size Ø 195 mm, height 100 mm.

Note:

Ordering Code in Bold & Italic indicates extended delivery period (8 to 10 weeks) Ex.: (LUABAEHVNN4N000)





**JETA 30 LED**  
 30W LED Floodlight

Lamp Type	Ordering Code	Optics	List Price Each (₹)	Case Lot (No)
1x30W LED 6K	<i>LHFD01130674</i>	General Spread	14000/-	01

JETA 30 LED, Asymmetrical Distribution floodlight is a new generation Energy Saving & Environment friendly luminaire which uses 30W high power LEDs as light source. LED Luminous efficacy is 97lm/w; Colour Rendering Index >75; Colour Temperature 6500K. The luminaire can be used for Sports Lighting, Area Lighting, Security Lighting, Signage Lighting, & Facade Lighting. Working lifetime is 50000 burning hours. Luminaire housing & Control Gear Box is of Cast Aluminium with Heat Sink for better heat transmission and Toughened Glass Cover which provides IP65 degree of protection. Operating Voltage range is from 100-277 Volt; Frequency range of 47-63Hz; Working temperature Range of (-)40° C to 50° C; Product Dimension of 225mm(L) X 186mm(W) X 152mm(H); Humidity level of 10% - 90% RH; Power Factor >0.95.



**ENDURA CITYLINER 24**  
 24W LED Street Light

Lamp Type	Ordering Code	Optics	List Price Each (₹)	Case Lot (No)
24W LED 6K	<i>LHRD02124674</i>	General Spread	17500/-	01

Complete Fixture  
 Suitable for pole dia Ø 35 mm (max.)

Endura City Liner 24, LED Street Light is a new generation Energy Saving & Environment friendly light fitting which uses 24 no. high power LEDs as light source. Total LED lumens 2400 lm. Working lifetime of over 50000 burning Hours and it uses Active Power Factor Correction (APFC) electronic gear (electronic driver). Luminaire housing is of pressure die-cast aluminum alloy LM6 for housing (Heat Sink) for better heat transmission. It has IP65 protection. Operating Voltage range is from 100Volt to 265 Volt AC and Frequency range of 50 - 60 Hz. Fitting is suitable for an ambient temperature from -40 deg C to + 50 deg C and Humidity level of 10% to 90% RH.



**ENDURA CITYLINER 48**  
 48W LED Street Light

Lamp Type	Ordering Code	Optics	List Price Each (₹)	Case Lot (No)
48W LED 6K	<i>LHRD02224674</i>	General Spread	35000/-	01

Complete Fixture  
 Suitable for pole dia Ø 35 mm (max.)

Endura City Liner 48, LED Street Light is a new generation Energy Saving & Environment friendly light fitting which uses 24 no. high power LEDs as light source. Total LED lumens 4800 lm. Working lifetime of over 50000 burning Hours and it uses Active Power Factor Correction (APFC) electronic gear (electronic driver). Luminaire housing is of pressure die-cast aluminum alloy LM6 for housing (Heat Sink) for better heat transmission. It has IP65 protection. Operating Voltage range is from 100Volt to 265 Volt AC and Frequency range of 50 - 60 Hz. Fitting is suitable for an ambient temperature from -40 deg C to + 50 deg C and Humidity level of 10% to 90% RH.



**ENDURA CITYLINER 90**  
 90W LED Street Light

Lamp Type	Ordering Code	Optics	List Price Each (₹)	Case Lot (No)
90W LED 6K	<i>LHRD01090674</i>	General Spread	55000/-	01

Complete Fixture  
 Suitable for pole dia Ø 50 mm (max.)

Endura City Liner 90, LED Street Light is a new generation Energy Saving & Environment friendly light fitting which uses 36 no. high power LEDs as light source. Total LED lumens 9000 lm. Working lifetime of over 50000 burning Hours and it uses Active Power Factor Correction (APFC) electronic gear (electronic driver). Luminaire housing is of pressure die-cast aluminum alloy LM6 for housing (Heat Sink) for better heat transmission. It has IP65 protection. Operating Voltage range is from 100Volt to 265 Volt AC and Frequency range of 50 - 60 Hz. Fitting is suitable for an ambient temperature from -40 deg C to + 50 deg C and Humidity level of 10% to 90% RH.



## ENDURA LITE SQ SWIVEL

Recess mounted cast Al. fitting plate in frosted silver finish in square profile, complete with extruded Al. heat sink for efficient heat dissipation and separate replaceable HF electronic driver

Lamp Type	Ordering Code	Optics	List Price Each (₹)	Case Lot (No)
4x3W LED 3K	LHOD02403374	25° spread	5600/-	01
4x3W LED 6K	LHOD02403674	25° spread	5600/-	01

ceiling cutout Ø 80 mm, height 51mm

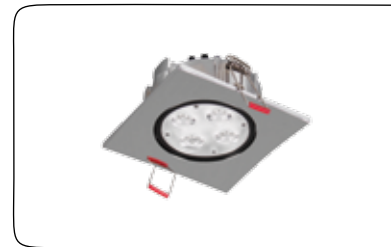

## ENDURA LITE RD SWIVEL

Recess mounted cast Al. fitting plate in frosted silver finish in round profile, fitted with extruded Al. heat sink for efficient heat dissipation and separate replaceable HF electronic driver

Lamp Type	Ordering Code	Optics	List Price Each (₹)	Case Lot (No)
4x3W LED 3K	LHOD01403374	25° spread	5600/-	01
4x3W LED 6K	LHOD01403674	25° spread	5600/-	01

ceiling cutout Ø 80mm, height 51mm



## ENDURA DL 7W/ 11W/ 16W

Endura LED downlighter in off white finish with milky white diffuser and elegantly designed extruded Al. heat sink for efficient heat dissipation along with HF driver.

Lamp Type	Ordering Code	Optics	List Price Each (₹)	Case Lot (No)
7W LED 3K	LHOD05007374	Diffused	7000/-	01
7W LED 6K	LHOD05007674	Diffused	7000/-	01
11W LED 3K	LHOD05011374	Diffused	8500/-	01
11W LED 6K	LHOD05011674	Diffused	8500/-	01
16W LED 3K	LHOD05016374	Diffused	9950/-	01
16W LED 6K	LHOD05016674	Diffused	9950/-	01

ceiling cutout sizes for DL 7W Ø 130mm, height 68mm, DL 11W Ø 155mm, height 68mm, DL 16W Ø 178mm, height 75mm



## ENDURA FLAT PANEL

36W LED modular fixture suitable for recess mounting/ armstrong ceiling and grid ceiling complete with HF electronic driver

Lamp Type	Ordering Code	Optics	List Price Each (₹)	Case Lot (No)
36W LED 3K	LHCD02036374	Diffused	19500/-	01
36W LED 6K	LHCD02036674	Diffused	19500/-	01

ceiling cutout 580x580 sq. mm



## ENDURA FLAT PANEL

48W LED modular fixture suitable for recess mounting/ armstrong ceiling and grid ceiling complete with separate HF electronic driver

Lamp Type	Ordering Code	Optics	List Price Each (₹)	Case Lot (No)
48W LED 3K	LHCD01048374	Diffused	34000/-	01
48W LED 6K	LHCD01048674	Diffused	30000/-	01

ceiling cutout 580x580 sq. mm



## ENDURA LITE LED FLEXI STRIP 5M IP20

Flexible LED strip in 5 Watt/mtr, with very wide viewing angle of 120° for good light dispersal IP20 construction, linkable and easy to install, complete with separate replaceable HF electronic driver

Lamp Type	Ordering Code	Optics	List Price Each (₹)	Case Lot (No)
24W LED 3K	LHJD01024398	120° spread	6000/-	01
24W LED 6K	LHJD01024698	120° spread	6000/-	01
HF Electronic Driver for 24W LED Flexi Strip	LHBD05148274	-	2750/-	01
72W LED 3K	LHJD01072398	120° spread	14000/-	01
72W LED 6K	LHJD01072698	120° spread	14000/-	01
HF Electronic Driver for 72W LED Flexi Strip	LHBD05196274	-	5000/-	01



**ENDURA LITE LED FLEXI STRIP 5M IP65**

Flexible LED strip in 5 Watt/mtr, with very wide viewing angle of 120° for good light dispersal IP65 construction, linkable and easy to install, complete with separate replaceable HF electronic driver

Lamp Type	Ordering Code	Optics	List Price Each (₹)	Case Lot (No)
24W LED 3K	<i>LHJD02024398</i>	120° spread	7000/-	01
24W LED 6K	<i>LHJD02024698</i>	120° spread	7000/-	01
HF Electronic Driver for 24W LED Flexi Strip	<i>LHBD06130274</i>	-	3200/-	01
72W LED 3K	<i>LHJD02072398</i>	120° spread	16000/-	01
72W LED 6K	<i>LHJD02072698</i>	120° spread	16000/-	01
HF Electronic Driver for 72W LED Flexi Strip	<i>LHBD06100274</i>	-	6100/-	01

**LED TUNNEL TEK L 56**

56W LED Tunnel Light

Lamp Type	Ordering Code	Optics	List Price Each (₹)	Case Lot (No)
56x1W LED 6K	<i>LHTD01156674</i>	General Spread	75000/-	01

LED Tunnel TEK L 56, Asymmetrical Distribution floodlight is a new generation Energy Saving & Environment friendly light fitting which uses 56 nos 1Watt high power LEDs of CREE as light source. LED Luminous efficacy is 100lm/w; Colour Rendering Index >75; Colour Temperature 6500K. The luminaire can be used for Sports Lighting, Area Lighting, Tunnel Lighting, Truss Lighting & Facade Lighting. Working lifetime is 50000 burning hours and it uses replacable Control Gear Box. Luminaire housing is of Extruded Aluminium with Heat Sink for better heat transmission and Toughened Glass Cover which provides IP65 degree of protection. Operating Voltage range is from 100-277Volt; Frequency range of 47-63Hz; Working temperature Range of (-)40° C to 50° C; Product Dimension of 1270mm(L)X130mm (W)X150mm(H); Humidity level of 10% - 90% RH; Power Factor >0.95; Beam Angle of 100° (Horizontal Axis) and 90° (Vertical Axis).

**LED TUNNEL TEK S 56**

56W LED Tunnel Light

Lamp Type	Ordering Code	Optics	List Price Each (₹)	Case Lot (No)
56x1W LED 6K	<i>LHTD02156674</i>	General Spread	75000/-	01

LED Tunnel TEK S 56, Asymmetrical Distribution floodlight is a new generation Energy Saving & Environment friendly light fitting which uses 56nos 1Watt high power LEDs of CREE as light source. LED Luminous efficacy is 100lm/w; Colour Rendering Index >75; Colour Temperature 6500K. The luminaire can be used for Sports Lighting, Area Lighting, Tunnel Lighting, Truss Lighting & Facade Lighting. Working lifetime is 50000 burning hours and it uses replacable Control Gear Box. Luminaire housing is of Extruded Aluminium with Heat Sink for better heat transmission and Toughened Glass Cover which provides IP65 degree of protection. Operating Voltage range is from 100-277Volt; Frequency range of 47-63Hz; Working temperature Range of (-)40° C to 50° C; Product Dimension of 402mm(L)X331mm(W) X224mm(H); Humidity level of 10% - 90% RH; Power Factor >0.95; Beam Angle of 100° (Horizontal Axis) and 90°(Vertical Axis).

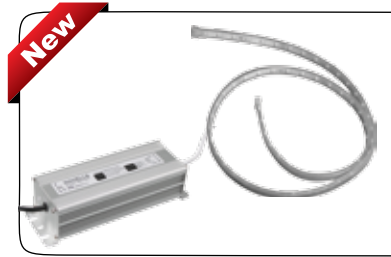



**T5 Flat Panel**

Recess mounted mirror optics luminaire with opal diffuser

Lamp Type	Ordering Code	Optics	List Price Each (₹)	Case Lot (No)
4x14W FTL T5	LHCT13414340	Diffused	5500/-	02
4x24W FTL T5	LHCT13424334	Diffused	5700/-	02

ceiling cutout 580x580mm

**Wingo Lite CM**

Recess mounted direct indirect mirror optics luminaire with central mirror & specially designed anodized aluminium wings.

Lamp Type	Ordering Code	Optics	List Price Each (₹)	Case Lot (No)
4x14W FTL T5	LHCTD2414340	Pre Ano Ref L2 Cat	6000/-	02
4x24W FTL T5	LHCTD2424334	Pre Ano Ref L2 Cat	6200/-	02

ceiling cutout 580x580mm

**Wingo Lite SM**

Recess mounted direct indirect mirror optics luminaire with side mirror & specially designed anodized aluminium wings.

Lamp Type	Ordering Code	Optics	List Price Each (₹)	Case Lot (No)
4x14W FTL T5	LHCTD3414340	Pre Ano Ref L2 Cat	6200/-	02
4x24W FTL T5	LHCTD3424334	Pre Ano Ref L2 Cat	6400/-	02

ceiling cutout 580x580mm

**Wingo Wall Washer 1x2**

Recess mounted mirror optics wall washer luminaire with specially designed anodized aluminium wings.

Lamp Type	Ordering Code	Optics	List Price Each (₹)	Case Lot (No)
2x14W FTL T5	LHCTD4214340	Pre Ano Ref L2 Cat	4000/-	02
2x24W FTL T5	LHCTD4224334	Pre Ano Ref L2 Cat	4100/-	02

ceiling cutout 580x280mm

**IVY MIRROR OPTIC**

Recess mounting luminaire for AS/GB/POP ceiling.

Lamp Type	Ordering Code	Optics	List Price Each (₹)	Case Lot (No)
Ivy Crystal : With Polycarbonate Anti Glare Cross Louvre				
2x14W FTL T5	LHCTP8214340	Polycarbonate	3000/-	02
2x24W FTL T5	LHCTP8224342	Polycarbonate	3400/-	02

Ceiling cutout size (mm): 580 x 280

Note : Surface mounted version available on request.

**IVY MIRROR OPTIC**

Recess mounting luminaire for AS/GB/POP ceiling.

Lamp Type	Ordering Code	Optics	List Price Each (₹)	Case Lot (No)
Ivy Crystal : With Polycarbonate Anti Glare Cross Louvre				
3x14W FTL T5	LHCTP8314331	Polycarbonate	4700/-	02
Ivy Classic : With Pre-anodised Aluminium Louvre				
3x14W FTL T5	LHCTD7314331	Pre-Ano. Ref. L2 Cat.	5000/-	02

Ceiling cutout size (mm): 580 x 580

Note : Surface mounted version available on request.



**IVY MIRROR OPTIC**

Recess mounting luminaire for AS/GB/POP ceiling

Lamp Type	Ordering Code	Optics	List Price Each (₹)	Case Lot (No)
Ivy Crystal : With Polycarbonate Anti Glare Cross Louvre 4x14W FTL T5	LHCTP8414340	Polycarbonate	5000/-	02
4x24W FTL T5	LHCTP8424342	Polycarbonate	5800/-	02
Ivy Classic : With Pre-anodised Aluminium Louvre 4x14W FTL T5	LHCTD7414340	Pre-Ano. Ref. L2 Cat.	5300/-	02

Ceiling cutout size (mm): 580 x 580

Note : Surface mounted version available on request.

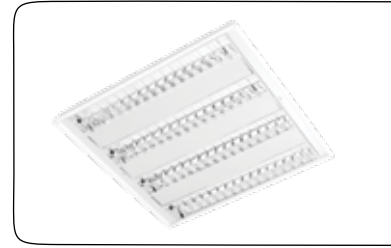

**IVY MIRROR OPTIC**

Recess mounting luminaire for AS/GB/POP ceiling

Lamp Type	Ordering Code	Optics	List Price Each (₹)	Case Lot (No)
Ivy Crystal : With Polycarbonate Anti Glare Cross Louvre 2x28W FTL T5	LHCTP8228333	Polycarbonate	5000/-	02
Ivy Classic : With Pre-anodised Aluminium Louvre 2x28W FTL T5	LHCTD7228333	Pre-Ano. Ref. L2 Cat.	5300/-	02

Ceiling cutout size (mm): 1180 x 280

Note : Surface mounted version available on request.

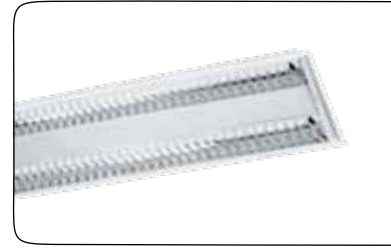

**MIRROR OPTIC T5**

Recess mounting compact optic luminaire for GB/POP ceiling

Lamp Type	Ordering Code	Optics	List Price Each (₹)	Case Lot (No)
1x28W FTL T5	LHCTN3128332	Non-category	2500/-	02
2x28W FTL T5	LHCTN3228333	Non-category	3800/-	02

Ceiling cutout size (mm): 1180 x 120 (1x28W T5) / 1180 x 210 (2x28W T5)

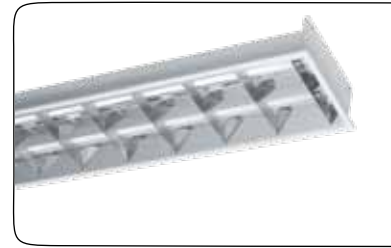

**SURFACE CUM RECESS T5 MIRROR OPTICS**

Lamp Type	Ordering Code	Optics	List Price Each (₹)	Case Lot (No)
1x28W FTL T5	LHCT71128432	Non-category	2300/-	02
2x28W FTL T5	LHCT71228433	Non-category	2850/-	02

Ceiling cutout size (mm): 1230 x 150 -1x28W FTL T5  
1230 x 185 -2x28W FTL T5

Note : Pre-Ano. Ref. L2 Cat. available on request.

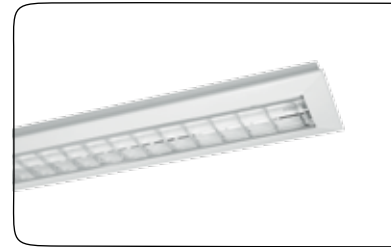

**ESPRIT MIRROR OPTIC SUSPENDED LUMINAIRE FOR UP-DOWN LIGHTING**

Lamp Type	Ordering Code	Optics	List Price Each (₹)	Case Lot (No)
2x28W FTL T5	LHCTE1228033	Pre-Ano. Ref. L2 Cat.	6000/-	01

Note: Suspension wire ropes included



**SURFACE MOUNTED EXTRUDED AL. COMPACT OPTICS T5 MIRROR OPTICS**

Lamp Type	Ordering Code	Optics	List Price Each (₹)	Case Lot (No)
2x28W FTL T5	LHCTN2228433	Non-category	4900/-	02

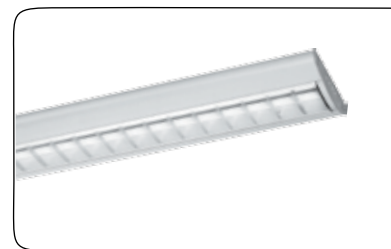

## MIRROR OPTICS GB/POP Series

Recess mounting mirror optic luminaire with P5 paralite louvre & electronic ballast

Lamp Type	Ordering Code	Optics	List Price Each (₹)	Case Lot (No)
1x36W FP-L (HF)	LHCC21136325	Paralite P5	2500/-	02

Ceiling cutout size (mm): 490 x 210

## MIRROR OPTICS AS/GB/POP Series

Recess mounting mirror optic luminaire with P5 paralite louvre & electronic ballast

Lamp Type	Ordering Code	Optics	List Price Each (₹)	Case Lot (No)
2x36W FP-L (HF)	LHCC20236327	Paralite P5	3200/-	02

Ceiling cutout size (mm): 580 x 280

## MIRROR OPTICS AS/GB/POP Series

Recess mounting mirror optic luminaire with P5 paralite louvre & electronic ballast

Lamp Type	Ordering Code	Optics	List Price Each (₹)	Case Lot (No)
2x36W FP-L (HF)	LHCC22236127	Paralite P5	4000/-	02
2x36W FP-L (HF)	LHCC22236325	Paralite P5	4000/-	02
3x36W FP-L (HF)	LHCC22336127	Paralite P5	4600/-	02
3x36W FP-L (HF)	LHCC22336325	Paralite P5	4600/-	02

Ceiling cutout size (mm): 580 x 580

## SOFTLINE NEW - Direct AS Series

Recess mounting direct indirect luminaire with P5 paralite louvre in perforated sheet & electronic ballast

Lamp Type	Ordering Code	Optics	List Price Each (₹)	Case Lot (No)
2x36W FP-L (HF)	LHCC58236127	Paralite P5	3600/-	02

Ceiling cutout size (mm): 580 x 580

## SOFTLINE NEW- AS Series

Recess mounting indirect luminaire with perforated sheet & electronic ballast

Lamp Type	Ordering Code	Optics	List Price Each (₹)	Case Lot (No)
2x36W FP-L (HF)	LHCC59236127	Perf. Lamp Shield	3400/-	02

Ceiling cutout size (mm): 580 x 580

## DECORA MIRROR OPTIC

Recess mounting mirror optics luminaire with anti glare louvre, polycarbonate wings & electronic ballast

Lamp Type	Ordering Code	Optics	List Price Each (₹)	Case Lot (No)
With Anti Glare Louvre & Polycarbonate wings. 2x36W HF	LHCC70236127	Direct/Indirect	4350/-	01

Ceiling cutout size (mm): 580 x 580

## MIRROR OPTICS AS Series

Recess mounting mirror optic luminaire with electronic ballast suitable for AS/GB/POP ceiling

Lamp Type	Ordering Code	Optics	List Price Each (₹)	Case Lot (No)
2x36W FP-L (HF)	LHCCN1236127	Non-category	2600/-	02

Ceiling cutout size (mm): 580 x 280





**MIRROR OPTICS AS Series**

Recess mounting mirror optic luminaire with electronic ballast suitable for AS/GB/POP ceiling

Lamp Type	Ordering Code	Optics	List Price Each (₹)	Case Lot (No)
3x36W FP-L (HF)	LHCCC2336127	L2 -category	4000/-	01

Ceiling cutout size (mm): 455 x 455

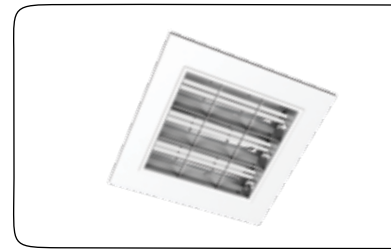

**MIRROR OPTICS AS/GB/POP Series**

Recess mounting mirror optic luminaire suitable for AS/GB/POP ceiling

Lamp Type	Ordering Code	Optics	List Price Each (₹)	Case Lot (No)
4x18/20W FTL	LHCFN3402111	Non-category	3600/-	02
	LHCFC3402111	L2-category	3800/-	02
4x18/20W FTL (HF)	<b>LHCFN3402325</b>	Non-category	3600/-	02
	<b>LHCFC3402325</b>	L2-category	3800/-	02

Ceiling cutout size (mm): 580 x 580



**SURFACE CUM RECESS MIRROR OPTICS**

Surface/Recess mounting mirror optics luminaire

Lamp Type	Ordering Code	Optics	List Price Each (₹)	Case Lot (No)
2x36/40W FTL	LHCFN1204811	Non-category	3000/-	02
2x36/40W FTL (HF)	LHCFN1204827	Non-category	3000/-	02
With Acrylic Cover				
2x36/40W FTL	<b>LHCFN2204911</b>	Non-category	4200/-	02

Ceiling cutout size (mm): 1230 x 200



**SURFACE CUM RECESS T8 MIRROR OPTICS**

Lamp Type	Ordering Code	Optics	List Price Each (₹)	Case Lot (No)
1x36W FTL T8	LHCF71136811	Non-category	2300/-	02
1x36W FTL T8 HF	<b>LHCF71136825</b>	Non-category	2300/-	02
2x36W FTL T8	LHCF71236811	Non-category	2900/-	02
2x36W FTL T8 HF	<b>LHCF71236827</b>	Non-category	2900/-	02

Ceiling cutout size (mm): 1275 x 160 -1x36W FTL T8, 1275 x 200 -2x36W FTL T8



**RECESS MOUNTING CFL/FP-L MIRROR OPTICS**

**MIRROR OPTICS Cabin Lite**

Recess mounting luminaire for CFL/FP-L

Lamp Type	Ordering Code	Optics	List Price Each (₹)	Case Lot (No)
2x18W DU (PL-C)	LHCCN3218311	Non-category	1400/-	02
2x18W FPL	<b>LHCCN2218311</b>	Non-category	1500/-	02
2x11W PL-S	LHCCN2211317	Non-category	1400/-	02
2x11W PL-S HF	<b>LHCCN2211354</b>	Non-category	1400/-	02

Ceiling cutout size (mm): 285 x 204 - 2x18W DU (PL-C), 290 x 195 - 2x11W PL-S

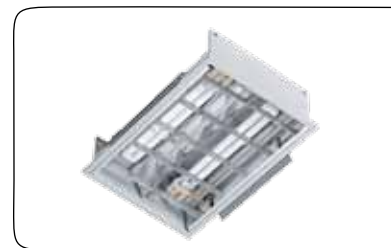

**MIRROR OPTIC - Cabin Lite**

Recess mounting mirror optic luminaire with P5 paralite louvre for CFL/FP-L

Lamp Type	Ordering Code	Optics	List Price Each (₹)	Case Lot (No)
2x11W PL-S	LHCC25211317	Paralite P5	1800/-	02
2x18W FP-L	LHCC25218311	Paralite P5	1970/-	02

Ceiling cutout size (mm): 280 x 280



**SURFACE MOUNTED CFL/FTL MIRROR OPTICS**

**MIRROR OPTICS OS Series Slim Cabin Lite**

Surface mounting luminaire for CFL

Lamp Type	Ordering Code	Optics	List Price Each (₹)	Case Lot (No)
2x18W DU (PL-C)	LHCCN4218411	Non-category	1300/-	02
2x18W DU (PL-C) HF	<b>LHCCN4218454</b>	Non-category	1350/-	02



**MIRROR OPTICS OS Series Slim Cabin Lite**

Surface mounting luminaire for CFL/FP-L

Lamp Type	Ordering Code	Optics	List Price Each (₹)	Case Lot (No)
2x11W PL-S	LHCCN2211417	Non-category	1400/-	02
2x11W PL-S HF	<b>LHCCN2211454</b>	Non-category	1450/-	02
2x18W FPL	<b>LHCCN2218411</b>	Non-category	1500/-	02



**MIRROR OPTICS OS Series - Slim**

Surface mounting mirror optics luminaire for FP-L

Lamp Type	Ordering Code	Optics	List Price Each (₹)	Case Lot (No)
2x36W FP-L HF	<b>LHCCN2236427</b>	Non-category	3050/-	02



**MIRROR OPTICS OS Series - Slim**

Surface mounting mirror optics luminaire

Lamp Type	Ordering Code	Optics	List Price Each (₹)	Case Lot (No)
1x36W FTL	LHCFN2136411	Non-category	2400/-	02
1x36W FTL (HF)	<b>LHCFN2136425</b>	Non-category	2400/-	02



**MIRROR OPTICS OS Series - Slim**

Surface mounting mirror optics luminaire

Lamp Type	Ordering Code	Optics	List Price Each (₹)	Case Lot (No)
2x36W FTL	LHCFN2236411	Non-category	3400/-	02
2x36W FTL (HF)	<b>LHCFN2236427</b>	Non-category	3400/-	02



Note:

- All CFL / FP-L / FTL luminaires are wired with OC 240 V, copper ballast/electronics ballast.
- 4x18/20W FTL, 2x18/20W FTL, 2x18W FP-L luminaires are wired with 110 V starter, with twin 36/40 W & single 36/40W copper ballast respectively.
- All FTL luminaires are HPF (High Power Factor), except where specifically mentioned otherwise.
- All FTL luminaires can be offered with high performance Electronic ballast (THD<10%) on request.
- All CFL luminaires, except 36W FP-L luminaires, are LPF (Low Power Factor) type. HPF versions are available on request with revised price.
- All T5 & HF version luminaires are wired with High Performance EB (THD<33%) as standard. High Performance EB (THD<10%) can be provided on request.
- AS-Arm Strong ceiling, GB-Gypsum Board ceiling, POP-Plaster Of Paris ceiling, LX - Luxlon ceiling.
- Ordering Code in Bold & Italics indicates extended delivery period (4 to 6 week) Ex.: (LHCTD7414340)

# HAVELLS DOWNLIGHTERS



## VERTICAL DOWNLITE DL 51

Vertical downlighter for retrofit CFL/GLS lamp

Lamp Type	Ordering Code	Optics	List Price Each (₹)	Case Lot (No)
upto 1x60W GLS/ 1x5/8W Retrofit CFL	LHOL51160399	Specular NB	400/-	12

Ceiling cutout size Ø 105 mm, height 110-130 mm



## VERTICAL DOWNLITE DL 53

Vertical downlighter for retrofit CFL/GLS lamp

Lamp Type	Ordering Code	Optics	List Price Each (₹)	Case Lot (No)
upto 1x60W GLS/ 1x11/20W Retrofit CFL	LHOL53160399	Specular NB	600/-	08

Ceiling cutout size Ø 155 mm, height 170 mm



## VERTICAL DOWNLITE DL 17

Vertical downlighter fitted with ballast

Lamp Type	Ordering Code	Optics	List Price Each (₹)	Case Lot (No)
1x18W PL-C	LHOC14118320	Specular NB	700/-	12

Ceiling cutout size Ø 120 mm, height 175 mm



## DOWNLITE DL 10

Recessed downlighter with matt finish reflector & fitted with ballast

Lamp Type	Ordering Code	Optics	List Price Each (₹)	Case Lot (No)
1x18W PL-C	LHOC10118320	Matt WB	985/-	08

Ceiling cutout size Ø 170 mm, height 100 mm



## DOWNLITE DL 10 E

Recessed downlighter with matt finish reflector & fitted with electronic ballast

Lamp Type	Ordering Code	Optics	List Price Each (₹)	Case Lot (No)
1x18W PL-C	LHOC10118354	Matt WB	1050/-	08

Ceiling cutout size Ø 170 mm, height 100 mm



## MODULAR DOWNLITE DL 12

Recessed downlighter with matt finish reflector

Lamp Type	Ordering Code	Optics	List Price Each (₹)	Case Lot (No)
upto 2x18W PL-C	LHOC12218399	Matt WB	820/-	08

Use suitable DL tray, price extra.

Ceiling cutout size Ø 170 mm, height 100 mm



# DOWNLIGHTER

## MODULAR DOWNLITE DL 12 E

Recessed downlighter with matt finish reflector & fitted with electronic ballast

Lamp Type	Ordering Code	Optics	List Price Each (₹)	Case Lot (No)
upto 2x18W PL-C	LHOC12218354	Matt WB	1600/-	08

Ceiling cutout size Ø 170 mm, height 100 mm

## MODULAR DOWNLITE DL 15N

Horizontal modular downlighter

Lamp Type	Ordering Code	Optics	List Price Each (₹)	Case Lot (No)
upto 2x18W PL-C	LHOC04218399	Specular WB	750/-	08

Use suitable DL tray, price extra.

Ceiling cutout size Ø 170 mm, height 90 mm

## HORIZONTAL MODULAR DOWNLITE DL 25

Horizontal modular downlighter

Lamp Type	Ordering Code	Optics	List Price Each (₹)	Case Lot (No)
upto 2x26W PL-C	LHOC35226399*	Spec. Parabolic	1150/-	08

Use suitable DL tray, price extra.

Ceiling cutout size Ø 200 mm, height 140 mm

\* with Sylvania brand

## DL 20 PLUS MODULAR DOWNLITE WITH CROSS LOUVRES

Recessed downlighter with specular finish cross louvres

Lamp Type	Ordering Code	Optics	List Price Each (₹)	Case Lot (No)
upto 2x18W PL-C	LHOC81218399	Specular WB	1700/-	08

Use suitable DL tray, price extra.

Ceiling cutout size Ø 184 mm, height 112 mm

## GDL 20 MODULAR DOWNLITE WITH CROSS LOUVRES

Recessed downlighter with specular finish cross louvres

Lamp Type	Ordering Code	Optics	List Price Each (₹)	Case Lot (No)
upto 2x26W PL-C	<b>LHOC80226399*</b>	Specular WB	2000/-	08

Use suitable DL tray, price extra.

Ceiling cutout size Ø 215 mm, height 150 mm

\* with Sylvania brand

## DL 21 PLUS MODULAR DOWNLITE WITH RADIAL TURBO LOUVRES

Recessed downlighter with specular finish turbo louvres

Lamp Type	Ordering Code	Optics	List Price Each (₹)	Case Lot (No)
upto 2x18W PL-C	<b>LHOC82218399</b>	Specular WB	1800/-	08

Use suitable DL tray, price extra.

Ceiling cutout size Ø 184 mm, height 112 mm

## MODULAR DOWNLITE WITH DIFFUSER DL 33

Recessed modular downlighter with diffuser

Lamp Type	Ordering Code	Optics	List Price Each (₹)	Case Lot (No)
upto 2x18W PL-C	LHOC33218399	General Diffuse	1200/-	08

Use suitable DL tray, price extra.

Ceiling cutout size Ø 170 mm, height 105 mm



**MODULAR DOWNLITE WITH DIFFUSER DL 34**

Recessed modular downlighter with curved glass

Lamp Type	Ordering Code	Optics	List Price Each (₹)	Case Lot (No)
upto 2x26W PL-C	LHOC34226399	Specular WB	1250/-	12

Use suitable DL tray, price extra.  
Ceiling cutout size Ø 196 mm, height 100 mm



**DL COMBO WITH EB & PATTERN GLASS**

Recessed downlighter with flat pattern glass, di-cast Al. ring & detachable electronic gear tray.

Lamp Type	Ordering Code	Optics	List Price Each (₹)	Case Lot (No)
2x18W PL-C/DU-CFL*	LHOC85218354	General Diffuse	2000/-	12

Ceiling cutout size Ø 200 mm, height 78 mm  
Electronic tray included.



**GDL 30 SQUARE MODULAR DOWNLITE WITH GLASS**

Square recessed downlighter with glass

Lamp Type	Ordering Code	Optics	List Price Each (₹)	Case Lot (No)
upto 2x26W PL-C	LHOC73226399	General Diffuse	1400/-	12

Use suitable DL tray, price extra.  
Ceiling cutout size Ø 205 mm, height 86 mm



**DL SQUARE MODULAR DOWNLITE WITH FROSTED GLASS**

Recessed downlighter with frosted flat glass

Lamp Type	Ordering Code	Optics	List Price Each (₹)	Case Lot (No)
2x18W PL-C/DU-CFL*	LHOC84218399	Diffuse WB	1400/-	08

Use suitable DL tray, price extra.  
Ceiling cutout size 130X130 mm, height 92 mm



**GDL 33 MODULAR DOWNLITE WITH GLASS**

Recessed downlighter with glass

Lamp Type	Ordering Code	Optics	List Price Each (₹)	Case Lot (No)
upto 2x26W PL-C	LHOC72226399	Specular WB	1400/-	08
upto 2x26W PL-C	LHOC82226399*	Specular WB	1400/-	08

Use suitable DL tray, price extra.  
Ceiling cutout size Ø 215 mm, height 150 mm  
\* with Sylvania brand



**MHL DOWNLITE DL 22**

Recessed downlighter for Metal Halide Double Ended lamp with frosted glass

Lamp Type	Ordering Code	Optics	List Price Each (₹)	Case Lot (No)
1x150W MHDE	LHOM22115399	General Diffuse	1300/-	12

Use suitable CGU for selected lamp source, price extra.  
Ceiling cutout size Ø 205 mm, height 158 mm



**MHL DOWNLITE DL 23**

Recessed downlighter for Metal Halide Double Ended lamp

Lamp Type	Ordering Code	Optics	List Price Each (₹)	Case Lot (No)
1x70W MH DE	LHOM04170099	Diffuse WB	1200/-	08
1x150W MH DE	LHOM04115099	Diffuse WB	1300/-	08

Use suitable CGU for selected lamp source, price extra.  
Ceiling cutout size Ø 155 mm, height 75 mm (70W MH DE)  
Ceiling cutout size Ø 215 mm, height 110 mm (150W MH DE)



## DOWNLIGHTER

### GDL WALL WASHER 70W G12 MODULAR DOWNLITE WITH GLASS

Recessed wall washer downlighter with glass

Lamp Type	Ordering Code	Optics	List Price Each (₹)	Case Lot (No)
1x70W CMI-T	LHOM75170399	Asymetric Wall Washer	2800/-	8

Use suitable CGU, price extra.

Ceiling cutout size Ø 250 mm, height 210 mm

### GDL 72 70W G12 MODULAR DOWNLITE WITH FROSTED GLASS

Recessed wall washer downlighter with angle adjustable arrangement

Lamp Type	Ordering Code	Optics	List Price Each (₹)	Case Lot (No)
1x70W CMI-T	LHOM76115399	Spot Wall Washer	2900/-	12

Use suitable CGU, price extra.

Ceiling cutout size Ø 180mm, height 145 mm

### GDL 73 150W G12 MODULAR DOWNLITE WITH GLASS

Recessed wall washer downlighter with angle adjustable arrangement

Lamp Type	Ordering Code	Optics	List Price Each (₹)	Case Lot (No)
1x150W CMI-T	LHOM77115399	Spot Wall Washer	2900/-	8

Use suitable CGU, price extra.

Ceiling cutout size Ø 185 mm, height 187 mm

### MHL WALL WASHER DL 24

Recessed downlighter with swivel arrangement for Metal Halide Double Ended lamp

Lamp Type	Ordering Code	Optics	List Price Each (₹)	Case Lot (No)
1x70W MH DE	LHOM24170399	Asy. Wall Washer	1350/-	08
1x150W MH DE	LHOM24115399	Asy. Wall Washer	1350/-	08
1x150W MH DE	LHOM34115399*	Asy. Wall Washer	1350/-	08

Use suitable CGU for selected lamp source, price extra.

Ceiling cutout size (mm): 225 x 135, height 128 mm

\* with Sylvania brand

### GDL 31 SURFACE INT DOWNLITE WITH GLASS

Sleek & round surface INT downlighter

Lamp Type	Ordering Code	Optics	List Price Each (₹)	Case Lot (No)
2x18W CFL EB	LHOC15218454	General Defuse	2400/-	10

Inclusive of ballast

### SURFACE DOWNLITE DL 31

Surface mounted downlighter fitted with ballast

Lamp Type	Ordering Code	Optics	List Price Each (₹)	Case Lot (No)
1x18W PL-C	LHOC14118420	Specular WB	1600/-	06
2x18W PL-C	LHOC16218420	Specular WB	1800/-	06
2x18W PL-C	LHOC16218420*	Specular WB	1800/-	06

\*Fitting in black colour

### CHANDELIER 1 NI upto 65W Retrofit Spiral CFL

Lamp Type	Ordering Code	List Price Each (₹)	Case Lot (No)
upto 65W Retrofit Spiral CFL	LHYC05165099	3500/-	04



**NON-MODULAR DL TRAY FOR CFL LAMPS**

Lamp Type	Ordering Code	List Price Each (₹)	Case Lot (No)
2x10/13W PL-C	LHGC01213018	700/-	10
2x18W PL-C	LHGC01218020	700/-	10
2x26W PL-C	LHGC01226021	1020/-	10

Ideal for indoor application.  
Not suitable for FP-L



**ELECTRONIC DL TRAY FOR CFL LAMPS**

Lamp Type	Ordering Code	List Price Each (₹)	Case Lot (No)
2x10/13W PL-C	LHGC01213054	700/-	04
2x18W PL-C	LHGC01218054	700/-	04
2x26W PL-C	LHGC01226054	1050/-	04

Ideal for indoor application.  
Not suitable for FP-L



**NUGGET**

Sleek & composite gear unit for (upto 5mtr)

Lamp Type	Ordering Code	List Price Each (₹)	Case Lot (No)
1x70W SON/MH	LHGW42170D36	1600/-	04
1x150W SON/MH	LHGW42115D36	2150/-	04

\*Ideal for indoor application.

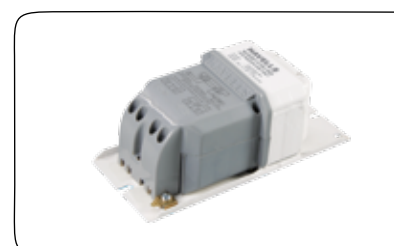

**CGU**

Sleek & composite gear unit for (upto 5mtr)

Lamp Type	Ordering Code	List Price Each (₹)	Case Lot (No)
1x70W SON/MH	LHGW01170D37	1600/-	04
1x150W SON/MH	LHGW01115D37	2150/-	04

\*Ideal for indoor application.



Note:

1. All downlighters are recommended for indoor use only.
2. Modular downlighters require separate DL Tray, price extra.
3. MHL downlighter & wall washer require separate control gear unit (CGU)/power pack of appropriate rating.
4. Ordering Code in Bold & Italics indicates extended delivery period (4 to 6 week) Ex.: (LHOC25226399)



**SPRING 1**

Decorative Non-Integral luminaire for Retrofit CFL lamp & low wattage HID lamp

Lamp Type	Product	Ordering Code	Optics	List Price Each (₹)	Case Lot (No)
1x45W CFL (ES) 1x70W SV/ MH SEE 1x150W MH SEE	Housing	LHLC13145099	Diffuse Bidirectional	15000/-	01

Suitable for pole dia Ø 76 mm.  
 Use separate control gear.



**SPRING 2**

Decorative Non-Integral luminaire for Retrofit CFL lamp & low wattage HID lamp

Lamp Type	Product	Ordering Code	Optics	List Price Each (₹)	Case Lot (No)
1x45W CFL (ES) 1x70W SV/ MH SEE 1x150W MH SEE	Housing	LHLC14145099	Diffuse Bidirectional	25000/-	01

Suitable for pole dia Ø 76 mm.  
 For 70W/150W MH SEE, use appropriate control gear which can be fitted in spigot.



**SPRING 3**

Decorative Non-Integral luminaire for Retrofit CFL lamp & low wattage HID lamp

Lamp Type	Product	Ordering Code	Optics	List Price Each (₹)	Case Lot (No)
1x45W CFL (ES) 1x70W SV/ MH SEE 1x150W MH SEE	Housing	LHLC15145099	Diffuse Bidirectional	20000/-	01

Suitable for pole dia Ø 76 mm.  
 For 70W/150W MH SEE, use appropriate control gear which can be fitted in spigot.



**POLES**

Suitable for Spring Series & Emperor Fixture pole dia Ø 76 mm.

Lamp Type	Ordering Code	List Price Each (₹)	Case Lot (No)
3.5 M	LHMP01135099	18000/-	01
6.0 M	LHMP01106099	30000/-	01

Note: 1) Pole to be mounted on 4no. 10mm J Type Foundation bolts at a PCD of 210mm.

**POLE FLANGE DETAILS**

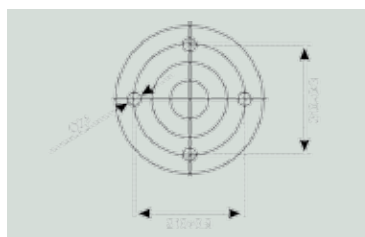



**POLARIS**

Decorative oriental design landscape lighting suitable for 1x26W retro CFL with opel diffuser.

Lamp Type	Ordering Code	Optics	List Price Each (₹)	Case Lot (No)
1x26W Retro CFL	LHLC41126099	Diffuse	4500/-	01

Suitable for pole dia Ø 50 mm.

**MAHARAJA**

Decorative non-integral luminaire with UV stabilized polycarbonate diffuser for Retrofit CFL lamp & low wattage HID lamp

Lamp Type	Ordering Code	Optics	List Price Each (₹)	Case Lot (No)
upto 1x85W CFL 70W SV/MH	<b>LHLY07185099</b>	Diffuse	4500/-	01

Use separate control gear for 70W SV/MH lamp & E27 lamp holder, price extra  
Suitable for pole dia Ø 60 mm.

**MAHARANI**

Decorative non-integral luminaire with UV stabilized polycarbonate diffuser for Retrofit CFL lamp & low wattage HID lamp

Lamp Type	Ordering Code	Optics	List Price Each (₹)	Case Lot (No)
upto 1x85W CFL B22 70W SV/MH	LHLY08185099	Diffuse	4000/-	01

Use separate control gear for 70W SV/MH lamp & E27 lamp holder, price extra  
Suitable for pole dia Ø 60 mm.

**JUPITER INTEGRAL**

Decorative luminaires for low/medium wattage HID lamps

Lamp Type	Product	Ordering Code	List Price Each (₹)	Case Lot (No)
1x70W MH DE	Housing	LHLM13170D99G	5260/-	01
	Ballast	LHBW08170036		08
1x150W MH DE	Housing	LHLM14115D99G	7495/-	01
	Ballast	LHBW08115036		06
1x70W SON/MH	Housing	LHLY13170C99G	5260/-	01
	Ballast	LHBW08170036		08

Suitable for pole dia Ø 50 mm.

**EMPEROR**

UV stabilized polycarbonate prismatic Meso Optic® luminaire (IP-65)

Lamp Type	Product	Ordering Code	List Price Each (₹)	Case Lot (No)
1x150W SON	Housing	LHLY10115D99	38500/-	01
	Ballast	LHBW08115036		06
1x250W SON/MH	Housing	LHLY10125D99	39300/-	01
	Ballast	LHBW18125036		04
1x400W SON/MH	Housing	LHLY10140C99	40500/-	01
	Ballast	LHBW08140036		04

Suitable for pole dia Ø 60 mm.

Each lamp housing & spigot supplied in separate packaging of 01 piece.

Meso Optic® create direct distribution on the appropriate cut-off to prevent high angle glare (in effect creating a virtual louvre) these also disperse light to create wide, uniform light distribution.

**PARC 1**

Round head extruded aluminium decorative garden/pathway fixture with opal top diffuser

Lamp Type	Ordering Code	Optics	List Price Each (₹)	Case Lot (No)
upto 1x26W CFL Spiral (B22)	LHLC04126099	Diffuse	9000/-	04



## PARC 2

Square head extruded aluminium decorative garden/pathway fixture with opal top diffuser

Lamp Type	Ordering Code	Optics	List Price Each (₹)	Case Lot (No)
upto 1x26W CFL Spiral (B22)	LHLC05126099	Diffuse	11000/-	04



## PARC DWARF

Architectural garden/pathway light made of pressure die-cast aluminium housing & frosted lens

Lamp Type	Ordering Code	Optics	List Price Each (₹)	Case Lot (No)
upto 1x26W CFL Spiral (B22)	LHLC06126099	Diffuse	9000/-	01



## GARDINA 1 & GARDINA 2

Extruded aluminium decorative luminaire for CFL (Retrofit)

Lamp Type	Ordering Code	Optics	List Price Each (₹)	Case Lot (No)
GARDINA 1 upto 1x26W CFL(TU)	LHLC01126099	Diffuse Bidirectional	5000/-	04
GARDINA 2 upto 1x26W CFL(TU)	LHLC02126099	Diffuse Omnidirectional	6500/-	04



## PLATINA

Pressure die cast decorative luminaire for CFL retrofit lamp (IP-65)

Lamp Type	Product	Ordering Code	List Price Each (₹)	Case Lot (No)
1x20W CFL Retro	Housing	LHLC12120099	12000/-	01



## RUGBY

Bulk head in die cast aluminium housing & frosted glass

Lamp Type	Ordering Code	Optics	List Price Each (₹)	Case Lot (No)
upto 1x8W CFL(TU)/ 100W GLS	LHKL01160099	Diffuse	600/-	12
Glass for RUGBY	LHYL01160099	-	Included	-



Note:

1. SON/MH indicates lamp enclosure suitable for either elliptical or tubular lamps.
2. SON-E/SO-N-T/MH SEE/MH SET indicates lamp enclosure/optics is designed for specified lamp shape only.
3. Ordering Code in Bold & Italics indicates extended delivery period (4 to 6 week) Ex.: (*LHLY10115D36*)



**PRODIGY\***

Ready to use retrofit T5 luminaire compatible with existing FTL T12 fixture by removing starter

Lamp Type	Ordering Code	Optics	List Price Each (₹)	Case Lot (No)
1x14W FTL T5	LHIT12114431	General Spread	900/-	10
1x28W FTL T5	LHIT12128432	General Spread	900/-	10

\* Suitable for batten/ Patti fittings specially.



**BATTEN EZ T5**

Powder coated Batten for T5 28W with replacable Electronic Ballast

Lamp Type	Ordering Code	Optics	List Price Each (₹)	Case Lot (No)
1x28W FTL T5	LHIT81128032	General Spread	850/-	10

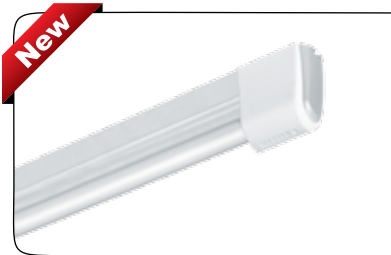

**BATTEN POPULAR T5**

Powder coated Batten for T5 28W

Lamp Type	Ordering Code	Optics	List Price Each (₹)	Case Lot (No)
1x28W FTL T5	LHIT12128032	General Spread	1000/-	10
2x28W FTL T5	LHIT11228033	General Spread	1450/-	10

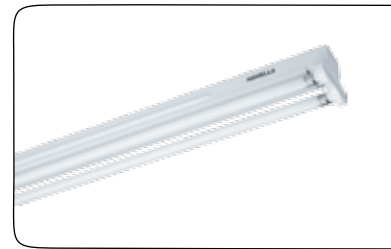

**ENERGY EFFICIENT T5 BATTEN**

Powder coated Batten for T5 28W with high performance EB (THD≤10%)

Lamp Type	Ordering Code	Optics	List Price Each (₹)	Case Lot (No)
1x28W FTL T5	LHIT01128050	General Spread	1100/-	10
2x28W FTL T5	LHIT01228051	General Spread	1800/-	10



**BATTEN POPULAR T5 PCR**

Powder coated batten with PC reflector for T5 28W

Lamp Type	Ordering Code	Optics	List Price Each (₹)	Case Lot (No)
1x28W FTL T5	LHIT12128032	Batwing	1500/-	10
PCR upto 2x28W T5	LHYT19228099			10
2x28W FTL T5	LHIT11228033	Batwing	1950/-	10
PCR upto 2x28W T5	LHYT19228099			10

Reflectors supplied in separate packaging of 10 pieces.



**BATTEN POPULAR T5 ALR**

Powder coated batten with pre-anodised aluminium reflector for T5 28W

Lamp Type	Ordering Code	Optics	List Price Each (₹)	Case Lot (No)
1x28W FTL T5 w/o cover	LHIT12128032	Batwing Specular	1800/-	10
ALR upto 2x28W T5	LHYT21228099			10
2x28W FTL T5 w/o cover	LHIT12228033	Batwing Specular	2250/-	10
ALR upto 2x28W T5	LHYT21228099			10

Reflectors supplied in separate packaging of 10 pieces.



## EXTRUDED ALUMINIUM T5 BATTEN WITH REFLECTOR

Lamp Type	Ordering Code	Optics	List Price Each (₹)	Case Lot (No)
1x28W FTL T5	LHIT04128032	Batwing Diffuse	1800/-	10
2x28W FTL T5	LHIT04228033	Batwing Diffuse	2800/-	10
1x54W FTL T5	LHIT04154071	Batwing Diffuse	2000/-	10
2x54W FTL T5	LHIT04254071	Batwing Diffuse	3000/-	10



## BATTEN GOLD

Powder coated Batten type luminaire with top cover - LPF/ HF  
Suitable for domestic application 230V, 50Hz supply only.

Lamp Type	Ordering Code	Optics	List Price Each (₹)	Case Lot (No)
1x36/40W FTL LPF	LHIF11104009	General Spread	900/-	10
1x36/40W FTL HF Electra	LHIF71104025	General Spread	800/-	10
2x36/40W FTL LPF	LHIF11204009	General Spread	1295/-	10
2x36/40W FTL HF Electra	LHIF71204025	General Spread	1125/-	10



## BATTEN GOLD

Powder coated Batten type luminaire with top cover - HPF/ HF  
Suitable for Industrial application 240V, 50Hz supply.

Lamp Type	Ordering Code	Optics	List Price Each (₹)	Case Lot (No)
1x36/40W FTL HPF	LHIF71104011	General Spread	1000/-	10
1x36/40W FTL HF	LHIF71104026	General Spread	1000/-	10
1x36/40W FTL HF	LHIF71104028*	General Spread	1100/-	10
2x36/40W FTL HPF	LHIF71204011	General Spread	1400/-	10
2x36/40W FTL HF	LHIF71204027	General Spread	1400/-	10
2x36/40W FTL HF	LHIF71204029*	General Spread	1800/-	10

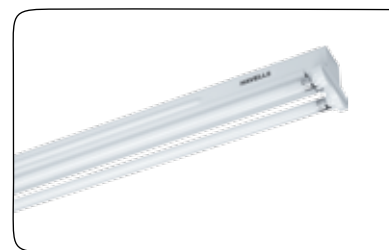

\* With high performance electronic ballast of THD $\leq$ 10%.

## BATTEN GOLD PCR

Powder coated Batten type luminaire without top cover with epoxy powder coated reflector - HPF  
Suitable for Industrial application 240V, 50Hz supply.

Lamp Type	Ordering Code	Optics	List Price Each (₹)	Case Lot (No)
1x36/40W FTL without cover PCR upto 2x36W FTL	LHIF33104011 LHYF19236099	Batwing	1600/-	10
2x36/40W FTL without cover PCR upto 2x36W FTL	LHIF33204011 LHYF19236099			10
		Batwing	2000/-	10



Reflectors supplied in separate packaging of 10 pieces.

## BATTEN GOLD ALR

Powder coated Batten type luminaire without top cover with anodised aluminium reflector - HPF  
Suitable for Industrial application 240V, 50Hz supply.

Lamp Type	Ordering Code	Optics	List Price Each (₹)	Case Lot (No)
1x36/40W FTL without cover ALR upto 2x36W FTL	LHIF33104011 LHYF20236099	Batwing Specular	2000/-	10
2x36/40W FTL without cover ALR upto 2x36W FTL	LHIF33204011 LHYF20236099			10
		Batwing Specular	2400/-	10



Reflectors supplied in separate packaging of 10 pieces.

## MAGNUM 1

Corrosion proof IP 65 fluorescent fitting in polycarbonate for wet location

Lamp Type	Ordering Code	Optics	List Price Each (₹)	Case Lot (No)
1x36W FP-L	LHIC53136011	Diffuse Spread	2000/-	04
2x36W FP-L	<b>LHIC54236011</b>	Diffuse Spread	3000/-	04
1x18W FTL	<b>LHIF54118007</b>	Diffuse Spread	2000/-	04
2x18W FTL	<b>LHIF54218015</b>	Diffuse Spread	3000/-	04
2x18W FTL HF	LHIF55218058	Diffuse Spread	3000/-	04
Emergency Power Pack with Nicd Battery				
2x18W FTL HF	<b>LHIF54218058</b>	Diffuse Spread	10000/-	04



**MAGNUM 2**

Corrosion proof IP 65 fluorescent fitting in polycarbonate for wet location

Lamp Type	Ordering Code	Optics	List Price Each (₹)	Case Lot (No)
1x28W FTL T5	LHIT55128032	Diffuse Spread	3000/-	06
2x28W FTL T5	LHIT56228033	Diffuse Spread	4000/-	04
1x36W FTL HF	LHIF55136026	Diffuse Spread	3200/-	06
2x36W FTL HF	LHIF56236027	Diffuse Spread	4200/-	04
Emergency Power Pack with Nicd Battery				
2x36W FTL	<b>LHIF56236025</b>	Diffuse Spread	11000/-	04



**CLEAN ROOM BOTTOM OPENING**

Recess mounting IP54 bottom opening clean room luminaire suitable for CFL/FTL lamps with EB (THD≤33%) with clear acrylic cover

Lamp Type	Ordering Code	Optics	List Price Each (₹)	Case Lot (No)
2x18W FP-L	<b>LHHC02218139</b>	Non-category	3370/-	02
2x36W FP-L	<b>LHHC03236127</b>	Non-category	4370/-	02
2x36W FP-L	<b>LHHC02236127</b>	Non-category	5670/-	02
3x36W FP-L	<b>LHHC02336127</b>	Non-category	6455/-	02
2x36/40W FTL	<b>LHHF02204127</b>	Non-category	4670/-	02
1x28W T5 FTL	<b>LHHT01128132*</b>	Non-category	3500/-	02
2x28W T5 FTL	<b>LHHT01228133*</b>	Non-category	5000/-	02



For dimension details, please refer to technical data sheet, also available with THD≤10% on request.

\* With polycarbonate cover.

**VPF 1 NI**

Non integral well glass luminaire

Lamp Type	Ordering Code	Optics	List Price Each (₹)	Case Lot (No)
1x200W GLS/ 125 MV/ 70W SON/ MH SEE/ 150W MH SEE*	LHVM16115099	General Spread	975/-	04
1x150W SON/E*	LHVS36115099	General Spread	1300/-	04



\* Use appropriate separate control gear for HID lamps, price extra

**VPF 1 New**

Integral well glass luminaire

Lamp Type	Product	Ordering Code	List Price Each (₹)	Case Lot (No)
1x70W SON-E/ MHSEE	Housing*	LHWV16170D99	3200/-	04
	Ballast	LHBW08170036		08
1x125W MV (ES)	Housing*	LHVG16112099	3150/-	04
	Ballast	LHBG08112036		08
1x150W SON-E	Housing*	LHVS26115A99	4445/-	04
	Ballast	LHBW08115036		08



\* Housing consists of lamp compartment & gear box, packed separately.

**VPF 2 Premium**

Vertical integral well glass luminaire in Pressure die-cast aluminium housing

Lamp Type	Product	Ordering Code	List Price Each (₹)	Case Lot (No)
1x70W SON/MH SEE	Housing*	LHWV27170D99	2900/-	01
	Ballast	LHBW08170036		08
1x125W MV (ES)	Housing*	LHVG27112099	2850/-	01
	Ballast	LHBG08112036		08
2x18W CFL (HF)	Housing**	LHVC26218054	2400/-	01
2x26W CFL (HF)	Housing**	LHVC26226054	2500/-	01



\* Housing consists of lamp compartment & gear box, packed separately.

\*\* Housing consists of lamp compartment & gear box with electronic ballast, packed separately.

**CANOPY- IP65**

Functional petrol pump/canopy light in die-cast alu. body & toughened glass (IP 65) for DE-Metal halide lamps

Lamp Type	Product	Ordering Code	List Price Each (₹)	Case Lot (No)
1x70W MH DE	Housing	<b>LHPY02170D99</b>	5285/-	01
	Ballast	LHBW08170036		08
1x150W MH DE	Housing	<b>LHPY02115D99</b>	5870/-	01
	Ballast	LHBW08115036		06



## CANOPY/ Single Ended - IP65

Functional petrol pump/canopy light in die-cast alu. body & toughened glass (IP 65) for SET-Metal halide lamps

Lamp Type	Product	Ordering Code	List Price Each (₹)	Case Lot (No)
1x250W MH SET	Housing Ballast	LHPY03125D99 LHBW19125036	7545 /-	01 04



## Non-integral Vertical HB/MB with full Aluminium Reflector (Open Type)

New		Housing		HB/MB Neck Reflector	
Lamp Type	LP	Ord. Code	LP	Ord. Code	LP
1x85W Retro CFL E27	2050/-	LHYW12185099	750/-	LHYW04125099	1300/-
1x150W SV-E } 250W SV	2050/-	LHYW12140099	750/-	LHYW04125099	1300/-
400W SV	2150/-	LHYW12140099	750/-	LHYW02140099	1400/-

Example: for 85W CFL Rerofit Non Integral vertical HB/MB  
Place order for - LHYW12185099 + LHYW04125099 (₹ 750/- + ₹ 1300/-)

## Non-integral Vertical HB/MB with full Aluminium Reflector (Enclosed Type)

New		Housing		HB/MB Neck Reflector		Glass	
Lamp Type	LP	Ord. Code	LP	Ord. Code	LP	Ord. Code	LP
1x150W MH-E E27	3000/-	LHYW12185099	750/-	LHYW04125099	1300/-	LHYW23125099	950/-
1x150W SV-E/ } 250W SV/ MH-E	3000/-	LHYW12140099	750/-	LHYW04125099	1300/-	LHYW23125099	950/-
400W SV/ MH-E	3300/-	LHYW12140099	750/-	LHYW02140099	1400/-	LHYW21140099	1150/-





Example: for Non Integral Vertical HB/MB 250W SV/MH-E neck reflector  
Place order for - LHYW12185099 + LHYW04125099 + LHYW23125099 (₹ 750/- + ₹ 1300/- + ₹ 950/-)

## COMBAY Half Aluminium & Half Polycarbonate Refractor

New		Housing		OC Ballast		HB/MB Neck Refractor	
Lamp Type	LP	Ord. Code	LP	Ord. Code	LP	Ord. Code	LP
1x250W SV/MH	13745/-	LHYW07125C99	3350/-	LHBW19125036	2395/-	LHYW07125099	8000/-
1x400W SV/MH	17545/-	LHYW07140C99	3350/-	LHBW08140036	3595/-	LHYW07140099	10600/-





Example: for Combay Half Al. half PC Refractor HB 250W SV/MH neck refractor (enclosed) with OC ballast  
Place order for - LHYW07125C99 + LHBW19125036 + LHYW07125099 (₹ 3350/- + ₹ 2395/- + ₹ 8000/-)

**COMBAY Full Aluminium Reflector (Open Type)**

	Housing	OC Ballast	HB/MB Neck Reflector				
							
Lamp Type	LP	Ord. Code	LP	Ord. Code	LP	Ord. Code	LP
1x250W SV	6995/-	LHYW07125C99	3350/-	LHBW19125036	2395/-	LHYW34140099	1250/-
1x400W SV	8195/-	LHYW07140C99	3350/-	LHBW08140036	3595/-	LHYW34140099	1250/-





Example: for Combay Vertical HB/MB 250W SV/MH neck reflector with OC Ballast  
Place order for - LHYW07125C99 + LHBW19125036 + LHYW34140099 (₹ 3350/- + ₹ 2395/- + ₹ 1250/-)

**COMBAY Full Aluminium Reflector (Enclosed Type)**





	Housing	OC Ballast	HB/MB Neck Reflector	Glass for HB/MB with Gasket & Toggles					
									
Lamp Type	LP	Ord. Code	LP	Ord. Code	LP	Ord. Code	LP	Ord. Code	LP
1x250W SV/MH	8145/-	LHYW07125C99	3350/-	LHBW19125036	2395/-	LHYW34140099	1250/-	LHYW34140199	1150/-
1x400W SV/MH	9345/-	LHYW07140C99	3350/-	LHBW08140036	3595/-	LHYW34140099	1250/-	LHYW34140199	1150/-

Example: for Combay Vertical HB/MB 250W SV/MH neck reflector (enclosed) with OC Ballast  
Place order for - LHYW07125C99 + LHBW19125036 + LHYW34140099 + LHYW34140199 (₹ 3350/- + ₹ 2395/- + ₹ 1250/- + ₹ 1150/-)

**CHANDELIER SEAL BEAM I**

	Housing	OC Ballast	HB/MB Neck Refractor				
							
Lamp Type	LP	Ord. Code	LP	Ord. Code	LP	Ord. Code	LP
1x70W SV/MH	6495/-	LHYW05170C99	2200/-	LHBW08170036	1095/-	LHYW05115099	3200/-
1x150W MH	6995/-	LHYW05115C99	2200/-	LHBW08115036	1595/-	LHYW05115099	3200/-

**CHANDELIER SEAL BEAM II**

	Housing	OC Ballast	HB/MB Neck Refractor				
							
Lamp Type	LP	Ord. Code	LP	Ord. Code	LP	Ord. Code	LP
1x150W SV	9545/-	LHYS07115C99	3350/-	LHBW08115036	1595/-	LHYW06125099	4600/-
1x250W SV/MH	10345/-	LHYW07125C99	3350/-	LHBW19125036	2395/-	LHYW06125099	4600/-
1x400W SV/MH	14445/-	LHYW07140C99	3350/-	LHBW08140036	3595/-	LHYW06140099	7500/-

Example: for CHANDELIER SEAL BEAM II 250W SV/MH neck refractor (enclosed) with OC ballast  
Place order for - LHYW07125C99 + LHBW19125036 + LHYW06125099 (₹ 3350/- + ₹ 2395/- + ₹ 4600/-)

# INDUSTRIAL LIGHTING

## URO BAY (Open Type)

Die-cast Al. housing with heat dissipation fins, easy to maintain (Top Opening).



Housing



OC Ballast



HB/MB Neck reflector



Lamp Type	LP	Ord. Code	LP	Ord. Code	LP	Ord. Code	LP
1x150W SV-E	6100/-	LHYW10115D99	3105/-	LHBW08115036	1595/-	LHYW10140099	1400/-
1x250W SV-E	6900/-	LHYW10125D99	3105/-	LHBW19125036	2395/-	LHYW10140099	1400/-
1x400W SV-E	8100/-	LHYW10140D99	3105/-	LHBW08140036	3595/-	LHYW10140099	1400/-

Example: Uro Bay 1x150W SV - E with neck reflector (Enclosed Type) & OC Ballast  
Place order for - LHYW10115D99 + LHBW08115036 + LHYW10140099 (₹ 3105/- + ₹ 1595/- + ₹ 1400/-)

## URO BAY (Enclosed Type)

Die-cast Al. housing with heat dissipation fins, easy to maintain (Top Opening)



Housing



OC Ballast



HB/MB Neck reflector



Glass for HB/MB with Gasket & Toggles



Lamp Type	LP	Ord. Code	LP	Ord. Code	LP	Ord. Code	LP	Ord. Code	LP
1x150W SV-E	7150/-	LHYW10115D99	3105/-	LHBW08115036	1595/-	LHYW10140099	1400/-	LHYW35140199	1050/-
1x250W SV/MH-E	7950/-	LHYW10125D99	3105/-	LHBW19125036	2395/-	LHYW10140099	1400/-	LHYW35140199	1050/-
1x400W SV/MH-E	9150/-	LHYW10140D99	3105/-	LHBW08140036	3595/-	LHYW10140099	1400/-	LHYW35140199	1050/-

Example: for Uro Bay Enclosed 1x150W SV/MH with neck reflector, OC Ballast & Glass  
Place order for - LHYW10115D99 + LHBW08115036 + LHYW10140099 + LHYW35140199 (₹ 3105/- + ₹ 1595/- + ₹ 1400/- + ₹ 1050/-)

## SUNDOWN VERTICAL HB/MB with Neck Reflector (Open Type)



Housing



OC Ballast

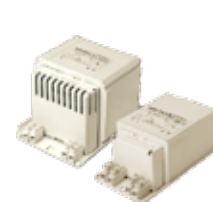

HB/MB Neck R eflctor



Lamp Type	LP	Ord. Code	LP	Ord. Code	LP	Ord. Code	LP
1x150W SON	5000/-	LHYS03115A99	2105/-	LHBW08115036	1595/-	LHYW04125099	1300/-
1x250W SV	6000/-	LHYW03125D99	2305/-	LHBW19125036	2395/-	LHYW04125099	1300/-
1x400W SV	7400/-	LHYW03140D99	2405/-	LHBW08140036	3595/-	LHYW02140099	1400/-
1x250W MV	5100/-	<b>LHYG03125099</b>	2005/-	LHBG08125036	1795/-	LHYW04125099	1300/-
1x400W MV	6000/-	<b>LHYG03140099</b>	2205/-	LHBG08140036	2395/-	LHYW02140099	1400/-

Example: for Sundown Vertical HB/MB 250W SV/MH neck reflector with OC Ballast  
Place order for - LHYW03125D99 + LHBW19125036 + LHYW04125099 (₹ 2305/- + ₹ 2395/- + ₹ 1300/-)

## SUNDOWN VERTICAL HB/MB with Neck Reflector (Enclosed)



Housing



OC Ballast



HB/MB Neck reflector



Glass for HB/MB with Gasket & Toggles







Lamp Type	LP	Ord. Code	LP	Ord. Code	LP	Ord. Code	LP	Ord. Code	LP
1x150W SON	5950/-	LHYS03115A99	2105/-	LHBW08115036	1595/-	LHYW04125099	1300/-	LHYW23125099	950/-
1x150W MH	5950/-	LHYM03115D99	2105/-	LHBW08115036	1595/-	LHYW04125099	1300/-	LHYW23125099	950/-
1x250W SV	6950/-	LHYW03125D99	2305/-	LHBW19125036	2395/-	LHYW04125099	1300/-	LHYW23125099	950/-
1x250W MH	6950/-	LHYW03125E99	2305/-	LHBW19125036	2395/-	LHYW04125099	1300/-	LHYW23125099	950/-
1x400W SV	8450/-	<b>LHYW03140D99</b>	2405/-	LHBW08140036	3595/-	LHYW02140099	1400/-	LHYW21140099	1050/-
1x400W MH	8450/-	<b>LHYW03140E99</b>	2405/-	LHBW08140036	3595/-	LHYW02140099	1400/-	LHYW21140099	1050/-
1x250W MV	6050/-	LHYG03125099	2005/-	LHBG08125036	1795/-	LHYW04125099	1300/-	LHYW23125099	950/-
1x400W MV	7050/-	LHYG03140099	2205/-	LHBG08140036	2395/-	LHYW02140099	1400/-	LHYW21140099	1050/-

Example: for Sundown Vertical HB/MB 250W SV/MH neck reflector (Enclosed) with OC Ballast  
Place order for - LHYW03125D99 + LHBW19125036 + LHYW04125099 + LHYW23125099 (₹ 2305/- + ₹ 2395/- + ₹ 1300/- + ₹ 950/-)









**ECO BAY full aluminium reflector (Open Type)**

Elegantly designed deep drawn sleek front opening housing, easy to maintain.

							
Lamp Type	LP	Ord. Code	LP	Ord. Code	LP	Ord. Code	LP
1x150W SV - E	5000/-	LHYW11125D99	2105/-	LHBW08115036	1595/-	LHYW04125099	1300/-
1x250W SV - E	5800/-	LHYW11125D99	2105/-	LHBW19125036	2395/-	LHYW04125099	1300/-

Example: Eco Bay 1x150W SV - E with neck reflector (Open Type) & OC Ballast  
Place order for - LHYW11125D99 + LHBW08115036 + LHYW04125099 (₹ 2105/- + ₹ 1595/- + ₹ 1300/-)

**ECO BAY full aluminium reflector (Enclosed)**

									
Lamp Type	LP	Ord. Code	LP	Ord. Code	LP	Ord. Code	LP	Ord. Code	LP
1x150W MH-E E27	5950/-	LHYW11115D99	2105/-	LHBW08115036	1595/-	LHYW04125099	1300/-	LHYW23125099	950/-
1x150W SV-E	5950/-	LHYW11125D99	2105/-	LHBW08115036	1595/-	LHYW04125099	1300/-	LHYW23125099	950/-
1x250W SV/MH-E	6750/-	LHYW11125D99	2105/-	LHBW19125036	2395/-	LHYW04125099	1300/-	LHYW23125099	950/-

Example: Eco Bay 1x150W MH - E with neck reflector (Enclosed Type) & OC Ballast  
Place order for - LHYW11115D99 + LHBW08115036 + LHYW04125099 + LHYW23125099 (₹ 2105/- + ₹ 1595/- + ₹ 1300/- + ₹ 950/-)

**T5 Highbay Enclosed Type**





Surface mounted/ suspended T5 highbay fitting with clear acrylic cover

Lamp Type	Ordering Code	Optics	List Price Each (₹)	Case Lot (No)
4x14W T5	<i>LHIT01414040</i>	Non-category	5500/-	02
4x24W T5	<i>LHIT01424034</i>	Non-category	6000/-	02
4x28W T5	<i>LHIT01428033</i>	Non-category	9200/-	02
4x28W T5	<i>LHIT02428033*</i>	Non-category	10000/-	02
4x54W T5	<i>LHIT01454071</i>	Non-category	10000/-	02

\* With polycarbonate cover.



**TRUNKING LIGHTING SYSTEM**

								
Sizes	Lamp Type	LP	Ord. Code	LP	Ord. Code	LP	Ord. Code	LP
1.2 mts.	2x28W T5 FTL	3500/-	<i>LHIF34000001</i>	1200/-	<i>LHYF34000001</i>	500/-	<i>LHIF34228033</i>	1300/-
3.6 mts.	(3x2)x28W T5 FTL	10000/-	<i>LHIF34000003</i>	3300/-	<i>LHYF34000003</i>	1400/-	<i>LHIF34228033</i>	1300/-
1.2 mts.	2x36W T8 FTL	3500/-	<i>LHIF34000001</i>	1200/-	<i>LHYF34000001</i>	500/-	<i>LHIF34236027</i>	1300/-
3.6 mts.	(3x2)x36W T8 FTL	10000/-	<i>LHIF34000003</i>	3300/-	<i>LHYF34000003</i>	1400/-	<i>LHIF34236027</i>	1300/-

Accessories:

- 1) 1.2 mts Bare Trunking Cover w/o Ballast: LHIF34100000 - LP ₹ 550/-
  - 2) End Caps: LHYF34000007 - LP ₹ 100/-
  - 3) C clamp & Suspension rod of 450mm length (LHYF34000008 - LP ₹ 300/-) to be used at every 1.8 mtr. in continuous installations.
- Example: For 1.2 mts. Trunking Lighting System : Place order for - 1 x LHIF34000001 + 2 x LHYF34000001 + 1 x LHIF34228033 (1 x 1200/- + 2 x 500/- + 1 x 1300/- = ₹ 3500/- )
- Example: For 3.6 mts. Trunking Lighting System : Place order for - 1 x LHIF34000003 + 2 x LHYF34000003 + 3 x LHIF34228033 (1 x 3300/- + 2 x 1400/- + 3 x 1300/- = ₹ 10000/-)

Note for Trunking Lighting System: End caps, C clamp & suspension rods are provided along with Trunking Lighting System as per the requirements.

Note:

1. All FP-L / FTL fittings except LPF type are wired with 240V, OC copper ballasts, LPF fittings are wired with 230V OC copper ballasts.
2. All FTL luminaires can be offered with high performance EB (THD <10%) on request.
3. All T5 & HF Version luminaires are wired with High Performance EB (THD<33%), as standard. high Performance EB (THD<10%) can be provided on request.
4. All HID luminaires are wired with heavy duty open construction copper ballast as standard, except wherever mentioned otherwise. HID ballast order should be placed separate along with the fitting.
5. Ordering Code in Bold & Italics indicates extended delivery period (4 to 6 week) Ex.: (LHIC54236011)



**ZING 1**

Polycarbonate flood light luminaire for high Wattage Retrofit CFL.

Lamp Type	Ordering Code	Optics	List Price Each (₹)	Case Lot (No)
1x65W Retro CFL (FU)	LHFC01165099	Asym. WB	3300/-	04

**ZING 2**

Polycarbonate flood light luminaire for twin high Wattage Retrofit CFL.

Lamp Type	Ordering Code	Optics	List Price Each (₹)	Case Lot (No)
2x65W Retro CFL (FU)	LHFC01265099	Asym. WB	5000/-	04

**JETA Mini**

Pressure die-cast aluminium floodlight luminaire for linear tungsten halogen lamp

Lamp Type	Ordering Code	Optics	List Price Each (₹)	Case Lot (No)
150W Halogen	LHFH05115099	Asym. WB	600/-	20

\*Inclusive of 150W Halogen Lamp

**JETA 1**

Pressure die-cast aluminium floodlight luminaire for linear tungsten halogen lamp

Lamp Type	Ordering Code	Optics	List Price Each (₹)	Case Lot (No)
500W Halogen	LHFH05150099	Asym. WB	800/-	12

**JETA 2**

Pressure die-cast aluminium floodlight luminaire for linear tungsten halogen lamp

Lamp Type	Ordering Code	Optics	List Price Each (₹)	Case Lot (No)
1000W Halogen	LHFH05110099	Asym. WB	1700/-	06

**JETA 2 CFL**

Pressure die-cast aluminium floodlight luminaire for Retrofit CFL

Lamp Type	Ordering Code	Optics	List Price Each (₹)	Case Lot (No)
1x26W CFL Retro (E27)	LHFC05126099	Asym. WB	1550/-	06

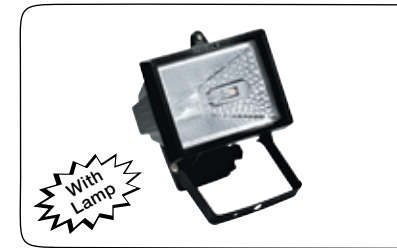

**RANGER 1 CFL**

Pressure die-cast aluminium floodlight luminaire for high Wattage Retrofit CFL

Lamp Type	Ordering Code	Optics	List Price Each (₹)	Case Lot (No)
upto 65W Spiral CFL Retro (E27)	LHFC46165099	Asym. WB	3230/-	01



**JETA 3 New IP65**

Pressure die-cast aluminium integral floodlight luminaire for MH DE lamp

Lamp Type	Product	Ordering Code	List Price Each (₹)	Case Lot (No)
1x 70W MH DE	Housing	LHFM04170D99	5000/-	01
	Ballast	LHBW08170036		08
1x150W MH DE	Housing	LHFM04115D99	5500/-	01
	Ballast	LHBW08115036		06



**JETA 5 IP65**

Pressure die-cast aluminium integral floodlight luminaire for 150W SON-T lamp

Lamp Type	Product	Ordering Code	List Price Each (₹)	Case Lot (No)
1x150W SON-T	Housing	LHFS05115C99	6500/-	01
	Ballast	LHBW08115036		04

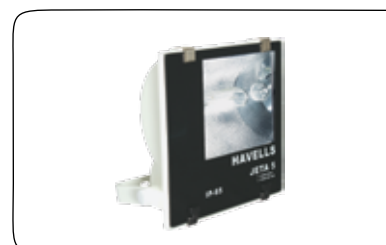

**JETA 6 RO IP66**

Pressure die-cast aluminium integral floodlight luminaire for SON-T/MH SET lamp

Lamp Type	Product	Ordering Code	List Price Each (₹)	Case Lot (No)
1x250W SON-T/MH SET	Housing	LHFY37125C99	8300/-	01
	Ballast	LHBW19125036		04
1x400W SON-T/MH SET	Housing	LHFY37140C99	9500/-	01
	Ballast	LHBW08140036		04



**JETA 6 New IP65**

Pressure die-cast aluminium integral floodlight luminaire for SON-T/MH SET lamp

Lamp Type	Product	Ordering Code	List Price Each (₹)	Case Lot (No)
1x250W SON-T/MH SET	Housing	LHFY36125C99	8500/-	01
	Ballast	LHBW19125036		04
1x400W SON-T/MH SET	Housing	LHFY36140C99	9700/-	01
	Ballast	LHBW08140036		04



**JETA 6 New IP65**

Pressure die-cast aluminium integral floodlight luminaire for SON-T/MH SET lamp

Lamp Type	Product	Ordering Code	List Price Each (₹)	Case Lot (No)
1x250W SON-T/MH SET	Housing	LHFY39125C99	8500/-	01
	Ballast	LHBW19125036		04
1x400W SON-T/MH SET	Housing	LHFY39140C99	9700/-	01
	Ballast	LHBW08140036		04



## JETA 6 New Assymmetric

Pressure die-cast aluminium integral floodlight luminaire for SON-T/MH SET lamp

Lamp Type	Product	Ordering Code	List Price Each (₹)	Case Lot (No)
1x250W SON-T/MH SET	Housing	LHFY40125C99	8500/-	01
	Ballast	LHBW19125036		04
1x400W SV/ MH SET	Housing	LHFY40140C99	9700/-	01
	Ballast	LHBW08140036		04

## JETA 7 IP65

Pressure die-cast aluminium integral compact wide beam floodlight for HID lamp

Lamp Type	Product	Ordering Code	List Price Each (₹)	Case Lot (No)
1x70W MH DE	Housing	LHFM40170D99	5000/-	01
	Ballast	LHBW08170036		08
1x70W SON/MH SET	Housing	LHFM41170C99	5000/-	01
	Ballast	LHBW08170036		08
1x150W MH DE	Housing	LHFM40115D99	5500/-	01
	Ballast	LHBW08115036		06

## RANGER 1 New NI IP65

Non-integral cast aluminium floodlight for single tubular HID lamps upto 400W.

Lamp Type	Ordering Code	Optics	List Price Each (₹)	Case Lot (No)
upto 1x400W SON-T/MH SET	LHFY46140099	Asym. WB	3800/-	01

Use appropriate CG box for selected lamp source & wattage, price extra

## RANGER 2 NI IP65

Non-integral cast aluminium floodlight for twin tubular HID lamps upto 400W.

Lamp Type	Ordering Code	Optics	List Price Each (₹)	Case Lot (No)
upto 2x400W SON-T/ MH SET	LHFY05240099	Asym. WB	7000/-	01

Use appropriate CG box for selected lamp sources & wattage, price extra

## RANGER 2 OVAL NI IP65

Non-integral cast aluminium floodlight for twin tubular HID lamps upto 400W.

Lamp Type	Ordering Code	Optics	List Price Each (₹)	Case Lot (No)
upto 2x400W SON-T/ MH SET	LHFY06240099	Asym. WB	7100/-	01

Use appropriate CG box for selected lamp sources & wattage, price extra

## ALFA 2 New NI (525mm) IP65

Non-integral cast al. housing, sym. spun al. reflector floodlight luminaire for single HID lamp upto 600W

Lamp Type	Product	Ordering Code	List Price Each (₹)	Case Lot (No)
upto 1x600W SON/ MH	Housing	LHFZ07140399	5700/-	04
	Reflector	LHFZ07140199		04
	Glass	LHFZ07140299		04

Use appropriate CG box for selected lamp source & Wattage, price extra

## ALFA 2 NI (570mm) IP65

Non-integral cast al. housing, sym. spun al. reflector floodlight luminaire for single HID lamp upto 1000W

Lamp Type	Ordering Code	Optics	List Price Each (₹)	Case Lot (No)
upto 1x1000W SON/ MH	LHFZ07140099	Symm. NB	6500/-	04

Use appropriate CG box for selected lamp source & Wattage, price extra



**BEAM**

Pressure die-cast aluminium sym. integral architectural floodlight for 150W MH SEQ/CMI-T lamp

Lamp Type	Product	Ordering Code	List Price Each (₹)	Case Lot (No)
1x70W MHSEQ	Housing	LHFM16170C99	10000/-	01
	Ballast	LHBW08117036		04
1x150W MHSEQ	Housing	LHFM16115C99	10500/-	01
	Ballast	LHBW08115036		04



Note:

1. In case of integral floodlight luminaires, housing and ballast packaged separately for transportation purposes.
2. All floodlight luminaires are fitted with toughened glass.
3. All HID floodlight luminaires are designed for tubular lamps for better performance.
4. Lamp type SON/MH indicates lamp enclosure suitable for either elliptical or tubular lamps.
5. Lamp type SON-E/SON-T/MH SEE/MH SET indicates lamp enclosure/optics is designed for specified lamp shape only.
6. Ordering Code in Bold & Italics indicates extended delivery period (4 to 6 week) Ex.: (LHFY50125C36)



**OPTAL 1 New - IP 66**

Architectural street light in pressure die-cast aluminium in two tone colour with ocean green on top cover & contrasting light grey finish on bottom suitable for low wattage HID lamps with sagged tempered glass lense

Lamp Type	Product	Ordering Code	List Price Each (₹)	Case Lot (No)
1x70W SON/MH (T)	Housing	LHRY32170C99	6500/-	01
	Ballast	LHBW08170036		08
1x150W MH (T) (E27)	Housing	LHRM32115C99	7000/-	01
	Ballast	LHBW08115036		06
1x150W SON-T (E40)	Housing	LHRS32115C99	7000/-	01
	Ballast	LHBW08115036		06

Suitable for pole dia Ø 50 mm (max.)

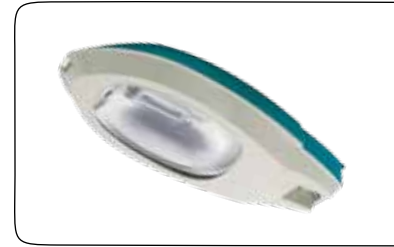

**OPTAL 2 New - IP 66**

Functional street light in pressure die-cast aluminium for medium wattage HID lamps with sagged tempered glass lense, with breathing port and flexible photometry.

Lamp Type	Product	Ordering Code	List Price Each (₹)	Case Lot (No)
1x150W SON-T	Housing	LHRS26115C99	9000/-	01
	Ballast	LHBW08115036		06
1x250W SON-T/ MH SET	Housing	LHRY26125C99	9800/-	01
	Ballast	LHBW19125036		04

Suitable for pole dia Ø 60 mm (max.)



**OPTAL 4 - IP 66**

Architectural street light in pressure die-cast aluminium for medium wattage HID lamps with sagged tempered glass lense, breathing port & flexible photometry.

Lamp Type	Product	Ordering Code	List Price Each (₹)	Case Lot (No)
1x150W SON-T	Housing	LHRS29115D99	8000/-	01
	Ballast	LHBW08115036		06
1x250W SON-T/MH SET	Housing	LHRY29125D99	8800/-	01
	Ballast	LHBW19125036		04

Suitable for pole dia Ø 50 mm (max.)



**ACCENT - IP 66**

Architectural street light in pressure die-cast aluminium for higher wattage HID lamps with sagged tempered glass lense and specially developed "Staircase Optic" & with breathing port.

Lamp Type	Product	Ordering Code	List Price Each (₹)	Case Lot (No)
1x250W SON/ MH SET	Housing	LHRY25125C99	14500/-	01
	Ballast	LHBW19125036		04
1x400W SON/ MH SET	Housing	LHRY25140C99	15700/-	01
	Ballast	LHBW08140036		04

Suitable for post top or bracket mounting dual option with supplied mounting clamp.  
 Suitable for pole dia Ø 60 mm (max.)



**IMPACT Plus DLX**

Streetlight luminaire in single pc. die-cast aluminium housing with "pot optics" & flat toughened glass.

Lamp Type	Product	Ordering Code	List Price Each (₹)	Case Lot (No)
1x250W SON-T/ MH SET	Housing	LHRY32125D99	7685/-	01
	Ballast	LHBW19125036		
1x400W SON-T	Housing	LHRY32140D99	9400/-	01
	Ballast	LHBW08140036		

Suitable for pole dia Ø 60 mm (max.)



**IMPACT Popular IP 65**

Streetlight luminaire in a single pc. die-cast aluminium housing with "pot optics" & flat toughened glass. Suitable for lower wattage HID lamps.

Lamp Type	Product	Ordering Code	List Price Each (₹)	Case Lot (No)
1x70W SON/MH-T	Housing	LHRY26170D99	4100/-	01
	Ballast	LHBW08170036		08
1x150W SON-T	Housing	LHRY26115D99	5800/-	01
	Ballast	LHBW08115036		06

Suitable for pole dia Ø 50 mm (max.)

**IMPACT Popular IP 65**

Streetlight luminaire in a single pc. die-cast aluminium housing with "pot optics" & flat toughened glass.

Lamp Type	Product	Ordering Code	List Price Each (₹)	Case Lot (No)
1x250W SON-T	Housing	LHRY26125D99	7200/-	01
	Ballast	LHBW19125036		04

Suitable for pole dia Ø 50 mm (max.)

**IMPACT Plus New IP 65**

Street light luminaire in a single pc. die-cast aluminium body in die cast with pot optics & flat toughened glass.

Lamp Type	Product	Ordering Code	List Price Each (₹)	Case Lot (No)
1x250W SON-T	Housing	LHRY31125D99	7400/-	01
	Ballast	LHBW19125036		04

Suitable for pole dia Ø 60 mm (max.)

**IMPACT Popular Acrylic IP 65**

Streetlight luminaire in a single pc. die-cast aluminium housing with "pot optics" & Acrylic Cover.

Lamp Type	Product	Ordering Code	List Price Each (₹)	Case Lot (No)
1x70W SON/MH-T	Housing	LHRY28170D99	4100/-	01
	Acrylic Cover	LHYW28170099		08
	Ballast	LHBW08170036		08
1x150W SON-T	Housing	LHRY28150D99	5800/-	01
	Acrylic Cover	LHYW28150099		08
	Ballast	LHBW08115036		06

Suitable for pole dia Ø 50 mm (max.)

**IMPACT Plus New Acrylic IP 65**

Streetlight luminaire in a single pc. die-cast aluminium housing with "pot optics" & Acrylic Cover.

Lamp Type	Product	Ordering Code	List Price Each (₹)	Case Lot (No)
1x250W SON-T	Housing	LHRY33125D99	7500/-	01
	Acrylic Cover	LHYW33125099		08
	Ballast	LHBW19125036		04

Suitable for pole dia Ø 60 mm (max.)

**ORION Popular Glass IP 65**

Street light luminaire in single pc. deep drawn aluminium housing with side reflector & toughened glass.

Lamp Type	Product	Ordering Code	List Price Each (₹)	Case Lot (No)
1x150W SON-T	Housing	LHRS05115D99	5195/-	01
	Ballast	LHBW08115036		04
1x250W SON-T	Housing	LHRS05125D99	5995/-	01
	Ballast	LHBW19125036		04

Suitable for pole dia Ø 50 mm (max.)



## ORION 2

Street light luminaire in a single pc. deep drawn aluminium housing with anodising inside & Acrylic Cover.

Lamp Type	Product	Ordering Code	List Price Each (₹)	Case Lot (No)
1x150W SON-T	Housing	LHRS04115A99	5295/-	01
	Acrylic Cover	LHYW32025099		08
	Ballast	LHBW08115036		06
1x250W SON-T	Housing	LHRS04125A99	6095/-	01
	Acrylic Cover	LHYW32025099		08
	Ballast	LHBW19125036		04

Suitable for pole dia Ø 60 mm (max.)



## ORION 1

Street light luminaire in a single pc. deep drawn aluminium housing with anodising inside & Acrylic Cover.

Lamp Type	Product	Ordering Code	List Price Each (₹)	Case Lot (No)
1x70W SON-T	Housing	LHRS04170A99	3710/-	01
	Acrylic Cover	LHYW32012099		08
	Ballast	LHBW08170036		08

Suitable for pole dia Ø 40 mm (max.)



## ORION - Retro 35

Street light luminaire in a single pc. deep drawn aluminium housing anodised inside & Acrylic Cover.

Lamp Type	Ordering Code	Optics	List Price Each (₹)	Case Lot (No)
1x35W Spiral Retro CFL B22	LHRC24136099	General Spread	1300/-	01

Complete with acrylic cover.  
Suitable for pole dia Ø 25 mm (max.)



## ORION - Retro 45

Street light luminaire in a single pc. deep drawn aluminium housing with anodising inside & Acrylic Cover.

Lamp Type	Ordering Code	Optics	List Price Each (₹)	Case Lot (No)
1x45W 4U Retro CFL B22	LHRC24145099	General Spread	1400/-	01

Complete with acrylic cover.  
Suitable for pole dia Ø 35 mm (max.)



## ORION - Retro 85

Street light luminaire in a single pc. deep drawn aluminium housing anodised inside & Acrylic Cover.

Lamp Type	Ordering Code	Optics	List Price Each (₹)	Case Lot (No)
1x85W 4U Retro CFL B22	LHRC24185099	General Spread	1550/-	01

Complete with acrylic cover.  
Suitable for pole dia Ø 35 mm (max.)



## ORION NOVA CFL

Street light luminaire in a single pc. deep drawn aluminium housing with side reflectors & Acrylic Cover.  
Suitable for upto 85W CFL Retrofit lamp.

Lamp Type	Product	Ordering Code	List Price Each (₹)	Case Lot (No)
1x85W CFL E27	Housing	LHRC13185099	2050/-	02
1x85W CFL B22	Housing	LHRC23185099	2050/-	02
	Acrylic Cover	LHYW11185099		08

Suitable for pole dia Ø 50 mm (max.)





**ORION NOVA New 70W SV**

Street light luminaire in a single pc. deep drawn aluminium housing with side reflectors & Acrylic Cover. Suitable for low wattage Sodium lamp.

Lamp Type	Product	Ordering Code	List Price Each (₹)	Case Lot (No)
1x70W SON-E	Housing	LHRS13170A99	3495/-	02
	Acrylic Cover	LHYW11185099		08
	Ballast	LHBW08170036		08

Suitable for pole dia Ø 50 mm (max.)

**ORION NOVA New 125W MV**

Street light luminaire in a single pc. deep drawn aluminium housing with side reflectors & Acrylic Cover. Suitable for 125W Mercury Vapour lamp.

Lamp Type	Product	Ordering Code	List Price Each (₹)	Case Lot (No)
1x125W MV	Housing	LHRG13112099	3335/-	02
	Acrylic Cover	LHYW11185099		08
	Ballast	LHBG08112036		08

Suitable for pole dia Ø 50 mm (max.)

**ORION NOVA New 150W SV**

Street light luminaire in a single pc. deep drawn aluminium housing with side reflectors & Acrylic Cover. Suitable for medium wattage Sodium lamp.

Lamp Type	Product	Ordering Code	List Price Each (₹)	Case Lot (No)
1x150W SON-E	Housing	LHRS11115A99	4545/-	02
	Acrylic Cover	LHYW11115099		08
	Ballast	LHBW08115036		06

Suitable for pole dia Ø 50 mm (max.)

**ORION NOVA 250W SV**

Street light luminaire in a single pc. deep drawn aluminium housing with side reflectors & Acrylic Cover. Suitable for higher wattage Sodium lamp.

Lamp Type	Product	Ordering Code	List Price Each (₹)	Case Lot (No)
1x250W SON-E	Housing	LHRS14125A99	5840/-	02
	Acrylic Cover	LHYW14025099		08
	Ballast	LHBW19125036		04

Suitable for pole dia Ø 50 mm (max.)

**CRYPTON DD Series for FP-L**

Compact street light luminaire with deep drawn Al. housing for single FP-L

Lamp Type	Ordering Code	Optics	List Price Each (₹)	Case Lot (No)
1x36W FP-L	LHRC04136011	General Spread	1550/-	04
1x36W FP-L HF	<b>LHRC04136026</b>	General Spread	1550/-	04

Complete with acrylic cover.  
Suitable for pole dia Ø35 mm (max.)

**CRYPTON DD Series for FP-L**

Compact street light luminaire with deep drawn Al. housing for twin FP-L

Lamp Type	Ordering Code	Optics	List Price Each (₹)	Case Lot (No)
2x36W FP-L	LHRC04236011	General Spread	2600/-	04
2x36W FP-L HF	<b>LHRC04236026</b>	General Spread	2600/-	04

Complete with acrylic cover.  
Suitable for pole dia Ø 35 mm (max.)



## CRYPTON FTL

Fluorescent street light luminaire with sheet aluminium body

Lamp Type	Ordering Code	Optics	List Price Each (₹)	Case Lot (No)
1x36/40W FTL	LHRF04104011	General Spread	1735/-	06
2x36/40W FTL	LHRF14204011	General Spread	2670/-	06

Acrylic covers supplied separately in packaging of 12 nos.  
Suitable for pole dia Ø 35 mm (max.)

## CRYPTON T5 FTL

Fluorescent street light luminaire with sheet aluminium body

Lamp Type	Ordering Code	Optics	List Price Each (₹)	Case Lot (No)
1x28W T5	LHRT05128032	General Spread	1850/-	06
2x28W T5	LHRT05228033	General Spread	2400/-	06

Complete with acrylic cover.  
Suitable for pole dia Ø 35 mm (max.)

## CRYPTON CA Series for T5 - IP65

Compact street light luminaire with Cast Al. housing & clear Acrylic cover for twin T5 Lamps.

Lamp Type	Ordering Code	Optics	List Price Each (₹)	Case Lot (No)
2x14W FTL T5	<b>LHRT16214040</b>	General Spread	3300/-	04
2x24W FTL T5	<b>LHRT16224034</b>	General Spread	3300/-	04

Complete with acrylic cover.  
Suitable for pole dia Ø 35 mm (max.)

## CRYPTON DD Series for T5

Compact street light luminaire with deep drawn Al. housing for twin T5 Lamps

Lamp Type	Ordering Code	Optics	List Price Each (₹)	Case Lot (No)
2x14W FTL T5	LHRT15214040	General Spread	3000/-	04
2x24W FTL T5	LHRT15224034	General Spread	3000/-	04

Complete with acrylic cover.  
Suitable for pole dia Ø 35 mm (max.)

## CRYPTON Series for T5

Compact street light luminaire with deep drawn MS housing for T5 Lamps

Lamp Type	Ordering Code	Optics	List Price Each (₹)	Case Lot (No)
CRYPTON MS				
4x14W T5	LHRT18414040	General Spread	6500/-	01
4x24W T5	LHRT18424034	General Spread	6500/-	01

Complete with acrylic cover.  
Suitable for pole dia Ø 50 mm (max.)

## CRYPTON New Series for T5

Elegant & Sleek Compact street light luminaire with deep drawn Al. housing for T5 Lamps

Lamp Type	Ordering Code	Optics	List Price Each (₹)	Case Lot (No)
CRYPTON DD				
4x14W T5	LHRT17414040	General Spread	7000/-	01
4x24W T5	LHRT17424034	General Spread	7000/-	01

Complete with acrylic cover.  
Suitable for pole dia Ø 50 mm (max.)

### Note:

- In case of HID street lights, housing, ballast and acrylic is packaged separately for transportation purpose.
- Lamp type SON/MH indicates lamp enclosure suitable for either elliptical or tubular lamps.
- Lamp type SON-E/SO-N-T/MH SEE/MH SET indicates lamp enclosure/optics is designed for specified lamp shape only.
- Ordering Code in Bold & Italics indicates extended delivery period (4 to 6 week) Ex.: (LHRS04170A36)





**DD POWER PACK**

Powder coated deep drawn housing control gear for single HID lamps

Lamp Type	Product	Ordering Code	List Price Each (₹)	Case Lot (No)
1x70W SV/MH	Housing	LHGW02170B99	2960/-	01
	Ballast	LHBW08170036		08
1x150W SV/MH	Housing	LHGW02115B99	3495/-	01
	Ballast	LHBW08115036		06
1x250W SV/MH	Housing	LHGW02125B99	4370/-	01
	Ballast	LHBW19125036		04



**DD POWER PACK**

Powder coated deep drawn housing control gear for single HID lamps

Lamp Type	Product	Ordering Code	List Price Each (₹)	Case Lot (No)
1x400W SV/MH	Housing	LHGW02140B99	5800/-	01
	Ballast	LHBW08140036		04



**CA POWER PACK**

Powder coated cast aluminium housing control gear for single HID lamps

Lamp Type	Product	Ordering Code	List Price Each (₹)	Case Lot (No)
1x70W SON/MH	Housing	LHGW04170B99	3095/-	02
	Ballast	LHBW08170036		08
1x150W SON/MH	Housing	LHGW04115B99	3795/-	02
	Ballast	LHBW08115036		06
1x250W SON/MH	Housing	LHGW04125B99	4695/-	02
	Ballast	LHBW19125036		04



**CA POWER PACK**

Powder coated cast aluminium housing control gear for single HID lamps

Lamp Type	Product	Ordering Code	List Price Each (₹)	Case Lot (No)
1x400W SON/MH	Housing	LHGW03140B99	6200/-	02
	Ballast	LHBW08140036		04



**CA POWER PACK FOR TWIN LAMPS**

Powder coated cast aluminium housing control gear for twin HID lamps

Lamp Type	Product	Ordering Code	List Price Each (₹)	Case Lot (No)
2x250W SON/MH	Housing	LHGW04225B99	9290/-	02
	Ballast	LHBW19125036		04
2x400W SON/MH	Housing	LHGW04240B99	12190/-	02
	Ballast	LHBW08140036		04



**NUGGET**

Sleek & composite gear unit for (upto 5mtr)

Lamp Type	Ordering Code	List Price Each (₹)	Case Lot (No)
1x70W SON/MH	LHGW42170D36	1600/-	04
1x150W SON/MH	LHGW42115D36	2150/-	04



## ACCESSORIES

### CGU

Sleek & composite gear unit for (upto 5mtr)

Lamp Type	Ordering Code	List Price Each (₹)	Case Lot (No)
1x70W SON/MH	LHGW01170D37	1600/-	04
1x150W SON/MH	LHGW01115D37	2150/-	04

\*Ideal for indoor application.

### OPEN CONSTRUCTION (OC) BALLAST for HID lamps - 240V 50Hz.

Lamp Type	Ordering Code	List Price Each (₹)	Case Lot (No)
✓ 1x35W CDMT/MH	LHBM01135036	890/-	08
1x70W SON/MH	LHBW08170036	1095/-	08
1x150W SON/MH	LHBW08115036	1595/-	06
1x250W SON/MH Spl.	LHBW18125036*	2395/-	04
1x250W SON/MH New	LHBW19125036*	2395/-	04
1x400W SON/MH	LHBW08140036	3595/-	04
1x125W HPMV	LHBG08112036	1100/-	08
1x250W HPMV	LHBG08125036	1795/-	06
1x400W HPMV	LHBG08140036	2395/-	04

\* Base plate & stack design as per 400W SON/MH OC ballast

### ELECTRONIC BALLAST for (CDMT/ CMI/ Quartz) MH lamp

Lamp Type	Ordering Code	List Price Each (₹)	Case Lot (No)
1x35W CMI	LHBI01135056	2755/-	12
1x70W CMI	LHBI01170057	2755/-	12
1x150W CMI	LHBI01115058	4620/-	06

### COPPER BALLASTS - Open construction

Copper wound heavy duty ballast for 240V, 20/40W FTL

Lamp Type	Ordering Code	List Price Each (₹)	Case Lot (No)
1x18/20W FTL/FP-L	LHBF18002015	325/-	24
1x36/40W FTL/FP-L	LHBF18004011	325/-	24

Low / superlow loss ballast available on request.

### COPPER BALLASTS for CFL

OC copper wound heavy duty ballast for 240V, for CFL

Lamp Type	Ordering Code	List Price Each (₹)	Case Lot (No)
1x26W PL-C	LHBC18026021	325/-	24

### ELECTRONIC BALLASTS for CFL

Lamp Type	Ordering Code	List Price Each (₹)	Case Lot (No)
1x9/11/13W CFL 4Pin	LHBC07113055	245/-	20
1x18W CFL 4Pin*	LHBC07118055	245/-	20
1x26W CFL 4Pin	LHBC07126055	295/-	20

\* Not suitable for FP-L

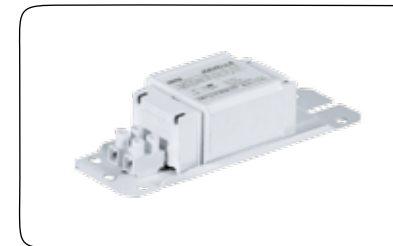
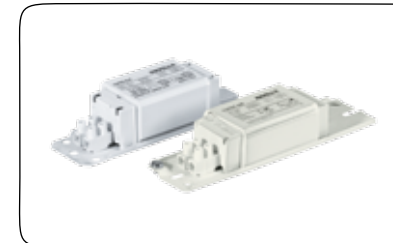
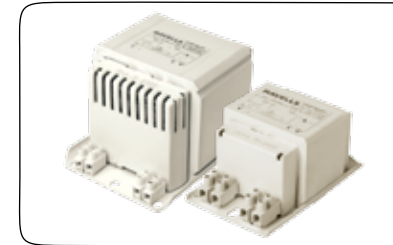

**ELECTRONIC BALLASTS** for T5/T8/T12 fluorescent lamp - High performance (THD<33%)

Lamp Type	Ordering Code	List Price Each (₹)	Case Lot (No)
1x14W FTL T5	LHBT01114031	600/-	20
2x14W FTL T5	LHBT01214040	875/-	20
1x28W FTL T5	LHBT01128032	600/-	20
2x28W FTL T5	LHBT01228033	875/-	20
1x54W FTL T5	LHBT01154071	850/-	20
1x36/40W FTL	LHBF07104026	600/-	20
2x36/40W FTL	LHBF07204027	875/-	20
2x18/20W FTL	LHBF07202039	875/-	20
1x24W FTL	LHBT01124024	675/-	20
2x24W FTL	LHBT01224034	875/-	20

**OLYMPIAN (ELECTRONIC BALLAST)**

Lamp Type	Ordering Code	List Price Each (₹)	Case Lot (No)
1x36/40W FTL	LHBF27904025	400/-	20

**ELECTRONIC BALLAST** for T5 / T8 / T12 Fluorescent lamps - High performance (THD<10%)

Lamp Type	Ordering Code	List Price Each (₹)	Case Lot (No)
1x14W FTL T5*	LHBT02114048	850/-	25
2x14W FTL T5	LHBT02214049	950/-	25
2x24W FTL T5 HO	LHBT02224042	1175/-	25
1x28W FTL T5	LHBT02128050	850/-	25
1x28W FTL T5 Slim	LHBT03128050	850/-	25
2x28W FTL T5	LHBT02228051	1175/-	25
1x36/40W FTL	LHBF08104028	800/-	25
2x36/40W FTL	LHBF08204029	1050/-	25
2x18/20W FTL*	LHBF08202022	1050/-	25

\*Available on request

**ANALOG DIMMABLE BALLAST** for FTL/ FP-L

Lamp Type	Ordering Code	List Price Each (₹)	Case Lot (No)
1x18/ 36/ 40W FTL/FP-L	ACUBP0514004	4150/-	01
2x18/ 36/ 40W FTL/FP-L	ACUBP0524004	4350/-	01
1x14/ 21/ 28/ 35W T5	ACUBT0513504	4150/-	01
2x14/ 21/ 28/ 35W T5	ACUBT0523504	4350/-	01
1x54W T5/ 58W T8	ACUBF0515804	4500/-	01
2x54W T5/ 58W T8	ACUBF0525804	5500/-	01

**ANALOG DIMMABLE BALLAST FOR CFL**

Lamp Type	Ordering Code	List Price Each (₹)	Case Lot (No)
1x18W CFL	ACUBC0511804	4150/-	01
2x18W CFL	ACUBC0521804	4350/-	01
1x26/ 32/ 42W CFL	ACUBC0514204	4150/-	01
2x26/ 32/ 42W CFL	ACUBC0524204	4350/-	01

**D TYPE SHORT DISTANCE IGNITORS WITH STUD** for 70-400W SON & MH lamps

Ignitor for	Ordering Code	List Price Each (₹)	Case Lot (No)
Short distance Ign.	LHNM07000D99	160/-	50

**IGNITORS** for 70-400W SON & MH lamps

Ignitor for	Ordering Code	List Price Each (₹)	Case Lot (No)
SON/MH lamp (S.D.) upto 5m	LHNM05000D99	160/-	50
SON/MH lamp (L.D.) upto 30m	LHNM17000B99	185/-	50
Super Imposed Ign.	LHNM27000C99	350/-	50
Super Imposed Ign. 2 Lead with stud	LHNM05000E99	350/-	50

S.D. is short distance, L.D. is long distance

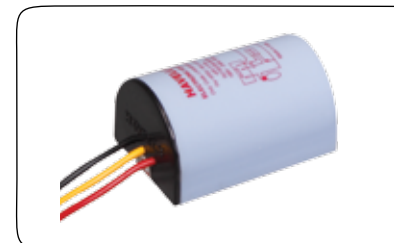
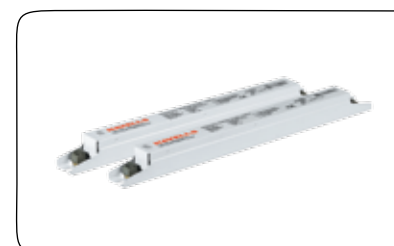
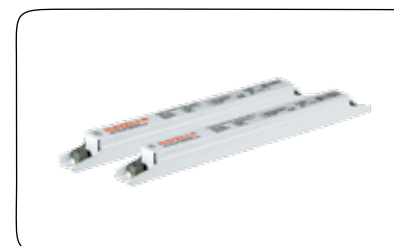

## CAPACITORS - 250V

Type	Ordering Code	List Price Each (₹)	Case Lot (No)
4 MFD	LHZF07104099	75/-	50
8 MFD	LHZF07108099	100/-	50
10 MFD	LHZZ07110099	120/-	50
15 MFD	LHZZ07115099	160/-	50
20 MFD	LHZZ07120099	220/-	50
33 MFD	LHZZ07133099	350/-	30
42 MFD	LHZZ07142099	400/-	20



## ALUMINIUM REFLECTOR (ALR)

Pre-anodised aluminium reflector for industrial Batten Gold luminaire for single & twin T8/T12 & T5 FTL

Lamp Type	Ordering Code	List Price Each (₹)	Case Lot (No)
1x36/2x36W FTL	LHYF20236099	1000/-	10
1x28/2x28W FTL T5	LHYT21228099	800/-	10



## POWDER COATED REFLECTOR (PCR)

Powder coated reflectors for industrial Batten Gold luminaire for single & twin T8/T12 & T5 FTL

Lamp Type	Ordering Code	List Price Each (₹)	Case Lot (No)
1x36/2x36W FTL	LHYF19236099	600/-	10
1x28/2x28W FTL T5	LHYT19228099	500/-	10



## ACRYLIC COVERS for Crypton DD series (Street Light Luminaire)

Lamp Type	Ordering Code	List Price Each (₹)	Case Lot (No)
Acrylic for 1x36W FP-L	LHYC04136099	225/-	12
Acrylic for 2x36W FP-L	LHYC04236099	275/-	12
Acrylic for 2x24W T5	LHYT16224099	275/-	12



## ACRYLIC COVERS for Crypton sheet aluminium series (Street Light Luminaire)

Lamp Type	Ordering Code	List Price Each (₹)	Case Lot (No)
Acrylic for 1x40W FTL	LHYF04104099	300/-	12
Acrylic for 2x40W FTL	LHYF14204099	400/-	12

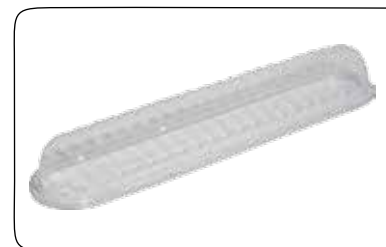

## LAMP HOLDERS for 18/20/36/40W FTL & 14/21/24/28 T5

Lamp Base	Ordering Code	List Price Each (₹)	Case Lot (No)
G 13	LHYF11000099	40/-	50
G 5	LHYT05128099	55/-	50



## LAMP HOLDERS for non-retrofit 5/7/9/11W CFL (PL-S)

Lamp Base	Ordering Code	List Price Each (₹)	Case Lot (No)
G 23	LHYC12000099	55/-	50



**LAMP HOLDERS** for non-retrofit 10/13/18/26W CFL (PL-C)

Lamp Base	Ordering Code	List Price Each (₹)	Case Lot (No)
G 24 D-1	LHYC13000099	65/-	25



**LAMP HOLDERS** for non-retrofit 18/24/36/55 W FP-L

Lamp Base	Ordering Code	List Price Each (₹)	Case Lot (No)
2 G 11	LHYC14000099	80/-	24

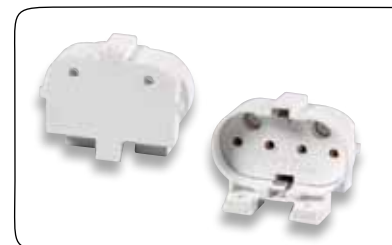

**LAMP HOLDERS** for single ended E/T lamps of 70/100W SV/ MH, 80/125MV and 150W MH

Lamp Base	Ordering Code	List Price Each (₹)	Case Lot (No)
E 27	LHYZ15000099	75/-	12



**LAMP HOLDERS** for 150/250/400/600 W SV, 250/400W MH and 250/400W MV

Lamp Base	Ordering Code	List Price Each (₹)	Case Lot (No)
E 40	LHYZ16000099	120/-	10



**STARTER HOLDERS** for 2ft. 18/20W, 4ft. 36/40W and 5ft. 65W FTL

Type	Ordering Code	List Price Each (₹)	Case Lot (No)
GU10	LHYF17000099	25/-	50



**STARTER HOLDERS** for Channel /box type FTL fixtures

Base Type	Ordering Code	List Price Each (₹)	Case Lot (No)
GU10	LHYF18000099	40/-	50



**STARTER** 110V for 2x18/ 20W FTL & 2x18W FP-L (CFL)

Type	Ordering Code	MRP Each (₹)	Case Lot (No)
FS2	LHNF07202000	28.75/-	250x4



**Item being Phased out**  
(Available for sale till stocks last)

**ENDURA CITYLINER S60**  
60W LED Street Light

Lamp Type	Ordering Code	Optics	List Price Each (₹)	Case Lot (No)
60x1W LED 6K	<b>LHRD01230674</b>	General Spread	60000/-	01

Complete Fixture  
Suitable for pole dia Ø 50 mm (max.)

Endura City Liner S60 LED Street Light is a new generation Energy Saving & Environment friendly light fitting which uses 60 no. 1W high power LEDs of CREE as light source. LED Luminous Efficacy is > 95lm/w. Working lifetime of over 50000 burning Hours and it uses Active Power Factor Correction (APFC) electronic gear (electronic driver). Luminaire housing is of pressure die-cast alluminum alloy LM24 for gear and extruded aluminium lamp housing (Heat Sink) for better heat transmission. It has epoxy powder coated siemens grey finish after phosphochromate treatment, IP65 protection. Operating Voltage range is from 85Volt to 264 Volt AC and Frequency range of 50 - 60 Hz. Fitting is suitable for an ambient temperature from -40 deg C to + 50 deg C and Humidity level of 10% to 90% RH.



**PIGMY SOFTLINE**

Recess mounting luminaire for FP-L

Lamp Type	Ordering Code	Optics	List Price Each (₹)	Case Lot (No)
2x18W FP-L	LHCC23218311	Perf. Lamp Shield	1945/-	02

Ceiling cutout size (mm): 280 x 280

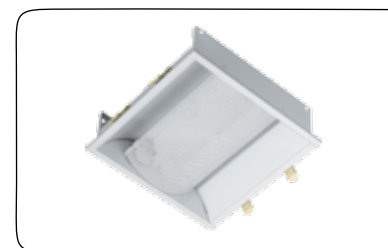

**PIGMY SOFTLINE - Direct**

Recess mounting luminaire with P5 paralite louvre for FP-L

Lamp Type	Ordering Code	Optics	List Price Each (₹)	Case Lot (No)
2x18W FP-L	LHCC24218311	Paralite P5	2220/-	02

Ceiling cutout size (mm): 280 x 280

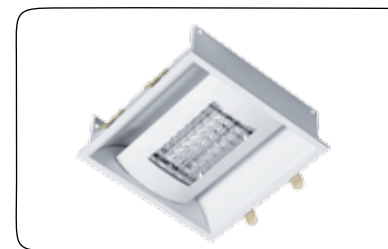

**MIRROR OPTICS LX/GB/POP Series**

Recess mounting mirror optic luminaire suitable for Luxalon strip (84-R) / jolly board ceiling

Lamp Type	Ordering Code	Optics	List Price Each (₹)	Case Lot (No)
1x36/40W FTL	LHCFN1104611	Non-category	2300/-	02
1x36/40W FTL (HF)	<b>LHCFN1104625</b>	Non-category	2300/-	02

Ceiling cutout size (mm): 1230 x 170

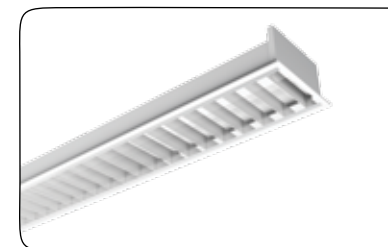

**MIRROR OPTICS LX/GB/POP Series**

Recess mounting mirror optic luminaire without centre V reflector suitable for LX/GB/POP ceiling

Lamp Type	Ordering Code	Optics	List Price Each (₹)	Case Lot (No)
2x36W FTL	LHCFN2236611	Non-category	2900/-	02

Ceiling cutout size (mm): 1230 x 170

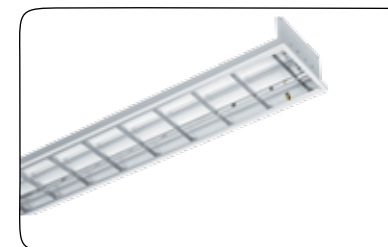

**MIRROR OPTICS OS T5**

Surface mounting compact optic luminaire

Lamp Type	Ordering Code	Optics	List Price Each (₹)	Case Lot (No)
1x28W FTL T5	LHCTN1128432	Non-category	3000/-	02
2x28W FTL T5	LHCTN1228433	Non-category	3500/-	02

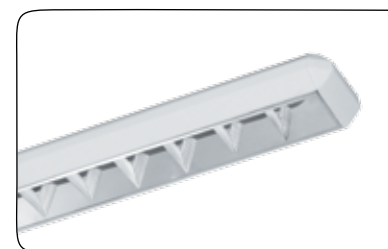



**Item being Phased out**  
(Available for sale till stocks last)

**GDL 60 FOR QR 111/INNOVA 111**

Recessed spotlight with angle adjustable arrangement

Lamp Type	Ordering Code	Optics	List Price Each (₹)	Case Lot (No)
1x50W QR 111 1x18W INNOVA 111	LHOH80150399	Spot Wall Washer	1350/-	12

Use suitable control gear, price extra.  
Ceiling cutout size 165x165 mm, height 84 mm



**GDL 61 FOR QR 111/INNOVA 111**

Recessed spotlight with angle adjustable arrangement

Lamp Type	Ordering Code	Optics	List Price Each (₹)	Case Lot (No)
2x50W QR 111 2x18W INNOVA 111	LHOH80250399	Spot Wall Washer	1850/-	12

Use suitable control gear, price extra.  
Ceiling cutout size 330x165 mm, height 84 mm



**GAMA GDL 62 FOR QR 111/INNOVA 111**

Recessed spotlight with angle adjustable arrangement

Lamp Type	Ordering Code	Optics	List Price Each (₹)	Case Lot (No)
3x50W QR 111 3x18W INNOVA 111	LHOH80350399	Spot Wall Washer	2400/-	06

Use suitable control gear, price extra.  
Ceiling cutout size 470x165 mm, height 90 mm



**GAMA GDL 63 FOR QR 111/INNOVA 111**

Recessed spotlight with angle adjustable arrangement

Lamp Type	Ordering Code	Optics	List Price Each (₹)	Case Lot (No)
4x50W QR 111 4x18W INNOVA 111	LHOH80450399	Spot Wall Washer	3200/-	04

Use suitable control gear, price extra.  
Ceiling cutout size 330x330 mm, height 90 mm



**GDL 35 MODULAR DOWNLITE WITH DROP GLASS**

Recessed downlighter with drop glass

Lamp Type	Ordering Code	Optics	List Price Each (₹)	Case Lot (No)
upto 2x26W PL-C	LHOC74226399	General Diffuse	1400/-	12

Use suitable DL tray, price extra.  
Ceiling cutout size Ø 200 mm, height 90 mm



**GDL 70 DE MODULAR DOWNLITE WITH DROP GLASS**

Recessed downlighter with drop glass

Lamp Type	Ordering Code	Optics	List Price Each (₹)	Case Lot (No)
1x70W MH DE	LHOM74170399	General Diffuse	1150/-	12

Use suitable CGU, price extra.  
Ceiling cutout size Ø 168 mm, height 110±2 mm



**GDL 71 150 DE MODULAR DOWNLITE WITH DROP GLASS**

Recessed downlighter with drop glass

Lamp Type	Ordering Code	Optics	List Price Each (₹)	Case Lot (No)
1x150W MH DE	LHOM74115399	General Diffuse	1475/-	12

Use suitable CGU, price extra.  
Ceiling cutout size Ø 200 mm, height 110 mm



**Item being Phased out**  
(Available for sale till stocks last)

**MODULAR WALL WASHER DOWNLITE DL 40**

Horizontal modular wall washer type downlighter

Lamp Type	Ordering Code	Optics	List Price Each (₹)	Case Lot (No)
upto 2x18W PL-C	<b>LHOC40218399</b>	Spec. Wall Washer	2400/-	08

Use suitable DL tray, price extra.

Ceiling cutout size Ø 212 mm, height 185±2 mm



**LINEAR**

Wall/recess mounting luminaire in die cast aluminium housing & frosted glass

Lamp Type	Ordering Code	Optics	List Price Each (₹)	Case Lot (No)
upto 1x15W CFL(TU)/ 60W GLS	LHKC05115099	Diffuse	750/-	12
Glass for LINEAR	LHYC05115099	-	Included	-

Cutout size 210 x 98 mm, depth 72 mm



**GARDINA 3**

Extruded aluminium decorative luminaire for CFL (Retrofit)

Lamp Type	Ordering Code	Optics	List Price Each (₹)	Case Lot (No)
upto 2x26W CFL	<b>LHLC03226099</b>	Diffuse Bidirectional	5170/-	01

Lamp head & pole supplied in separate packaging



**BATTEN POPULAR T5**

Powder coated Batten for T5 28W

Lamp Type	Ordering Code	Optics	List Price Each (₹)	Case Lot (No)
2x28W FTL T5	LHIT11228033	General Spread	1450/-	10

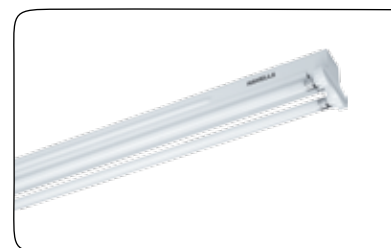

**ENERGY EFFICIENT T5 BATTEN**

Powder coated Batten for T5 28W

Lamp Type	Ordering Code	Optics	List Price Each (₹)	Case Lot (No)
1x28W FTL T5	LHIT01128032	General Spread	1150/-	10
2x28W FTL T5	LHIT01228033	General Spread	1600/-	10

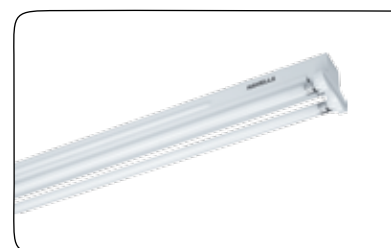

**VPF 2 New**

Vertical integral well glass luminaire

Lamp Type	Product	Ordering Code	List Price Each (₹)	Case Lot (No)
1x70W SON/MH SEE	Housing*	LHW26170D99	2635/-	01
	Ballast	LHBW08170036		08
1x125W MV (ES)	Housing*	LHVG26112099	2540/-	01
	Ballast	LHBG08112036		08

\* Use appropriate separate control gear for HID lamps, price extra

Note : 2x18W & 2x26W CFL version with electronic ballast available on request.



**VPF 2**

Vertical integral well glass luminaire

Lamp Type	Ordering Code	Optics	List Price Each (₹)	Case Lot (No)
1x150W SON/E*	LHVS25115099	General Spread	1615/-	01

\* Use appropriate separate control gear for HID lamps, price extra



## Item being Phased out (Available for sale till stocks last)

### CANOPY- IP65

Functional petrol pump/ canopy light & die-cast alu. body & toughened glass lense (IP 65) for DE-Metal halide lamps

Lamp Type	Product	Ordering Code	List Price Each (₹)	Case Lot (No)
1x70W MH DE	Housing	<b>LHPY01170D99</b>	4895/-	01
	Ballast	LHBW08170036		08
1x150W MH DE	Housing	<b>LHPY01115D99</b>	5450/-	01
	Ballast	LHBW08115036		06



### BOTTOM OPENING CLEAN ROOM

Recess mounting IP54 bottom opening clean room luminaire suitable for CFL / FTL lamps

Lamp Type	Ordering Code	Optics	List Price Each (₹)	Case Lot (No)
2x18W FP-L	<b>LHHC01218111</b>	Non-category	2570/-	02
2x36W FP-L	<b>LHHC02236111</b>	Non-category	3370/-	02
2x36W FP-L	<b>LHHC01236111</b>	Non-category	4370/-	02
2x36/40W FTL	<b>LHHF01204111</b>	Non-category	4270/-	02



For dimension details, please refer to technical data sheet.

### JETA 4

Pressure die-cast aluminium integral floodlight luminaire for MH DE lamp of 250W Rx7s lamp holder

Lamp Type	Product	Ordering Code	List Price Each (₹)	Case Lot (No)
1x250W MH DE	Housing	LHFM05125D99	6395/-	01
	Ballast	LHBW19125036		04



### FOCAL I INT

Pressure die-cast aluminium sym. integral architectural floodlight for G12 base MH SEQ lamp

Lamp Type	Ordering Code	Optics	List Price Each (₹)	Case Lot (No)
1x70W MH SEQ	LHFM15170C36	Symm. NB	8130/-	04
1x150W MH SEQ	LHFM15115C36	Symm. NB	8765/-	04



### FOCAL 2 INT IP65

Pressure die-cast aluminium sym. integral architectural floodlight for 250W tubular HID lamp

Lamp Type	Product	Ordering Code	List Price Each (₹)	Case Lot (No)
1x250W SON/MHSET	Housing	LHFM15125C99	13845/-	01
	Ballast	LHBW19125036		04



### IMPACT Popular IP 65

Streetlight luminaire in a single pc. die-cast aluminium housing with "pot optics" & flat toughened glass. Suitable for lower wattage HID lamps.

Lamp Type	Product	Ordering Code	List Price Each (₹)	Case Lot (No)
1x150W SON-T	Housing	LHRY26150D99	5800/-	01
	Ballast	LHBW08115036		06



Suitable for pole dia Ø 50 mm (max.)

### IMPACT PLUS GLASS VERSION (IP 65)

Street light luminaire in a single pc. aluminium body in die cast with pot optics & flat toughened glass

Lamp Type	Product	Ordering Code	List Price Each (₹)	Case Lot (No)
1x250W SON-T	Housing	LHRS21125A99	6695/-	01
	Ballast	LHBW19125036		04



Suitable for pole dia Ø 60 mm (max.)

Item being Phased out  
(Available for sale till stocks last)

**IMPACT PLUS ACRYLIC IP 65**

Street light luminaire in a single pc. aluminium body in die cast with pot optics & acrylic cover

Lamp Type	Product	Ordering Code	List Price Each (₹)	Case Lot (No)
1x250W SON-T	Housing	LHRS20125A99	6695/-	01
	Acrylic Cover	LHYW20125099		08
	Ballast	LHBW19125036		04

Suitable for pole dia Ø 60 mm (max.)

**CRYPTON SERIES FOR T5**

Compact street light luminaire with deep drawn Al. housing for FTL T5

Lamp Type	Ordering Code	Optics	List Price Each (₹)	Case Lot (No)
CRYPTON DD				
4x14W T5	<b><i>LHRT15414049</i></b>	General Spread	7250/-	01
4x24W T5	<b><i>LHRT15424034</i></b>	General Spread	7250/-	01
4x24W T5	<b><i>LHRF15424042</i></b>	General Spread	7250/-	01

Complete with acrylic cover.

Suitable for pole dia Ø 50 mm (max.)

**SOLAR 2**

Lowbay/midbay luminaire for higher wattage HID lamps

Lamp Type	Product	Ordering Code	List Price Each (₹)	Case Lot (No)
1x150W SON-E	Housing	<b><i>LHIS11115A99</i></b>	4420/-	01
	Ballast	LHBW08115036		06

**ALUMINIUM REFLECTOR (ALR)**

Pre-anodised aluminium reflector for industrial Batten Gold luminaire for single & twin T8/T12 & T5 FTL

Lamp Type	Ordering Code	List Price Each (₹)	Case Lot (No)
1x28/2x28W FTL T5	LHYT20228099	800/-	10

**COMPOSITE GEAR UNIT (CGU\*) SD for SON/MH Lamps with short distance ignitor (upto 5mtr)**

Lamp Type	Ordering Code	List Price Each (₹)	Case Lot (No)
1x70W SON/MH	LHGW411170D36	1600/-	04
1x150W SON/MH	LHGW41115D36	2150/-	04

\*Ideal for indoor application.

Note: Ordering Code in Bold & Italics indicates extended delivery period (4 to 6 week) Ex.: (***LHCT71224134***)









## Don't let the nights stop your quest. Special Road Lighting from Havells.

Nights are the most beautiful times to be out. Thanks to the special road lights from Havells which ensure that the roads are brightly lit like the sky above. Go out, explore the world at night and let our road lights guide you on your quest.



Impact Plus Dlx



Optal 1 New



Optal 2 New



Impact Plus New Acrylic

E-mail: [marketing@havells.com](mailto:marketing@havells.com), [www.havells.com](http://www.havells.com),  
Consumer Care No.: 1800 103 1313 (All connections), 011-4166 0303 (Landline)



# HAVELLS

Regional & Branch Offices :

**NORTH - REGIONAL OFFICE:** Delhi: QRG Towers, 2D, Sector-126, Expressway, Noida-201304, Tel: 0120-4771000, Fax: 0120-4772000, Chandigarh: Tel: 0172 4232400-401, Fax: 0172-4232403, Dehradun: Tel: 0135-2521025, 2521552, Haryana: Tel: 91-120 2477848 / 853, Fax: 0120-2583904, Noida: Tel: 0120-3055609/3055610, Fax: 0120-3055611, Ludhiana: Tel: 0161-4676001 / 6024, Fax: 0161-46766007, Jammu: Tel: 0191-2490424, Fax: 0191-2490405, Jaipur: Tel: 0141-3988210, Fax: 0141-2389024, Kanpur: Tel: Airtel: 09935533751 /52/53, 0512-2690128/129/130, Fax: 0512-2692800, Lucknow: 0522-2201032,2200938

**EAST - REGIONAL OFFICE:** Kolkata: ICC Tower, 5th Floor, 4 India Exchange Place, Kolkata-700001, Tel: 033-40129851/52, Fax: 033-40127339, Bhubaneswar: Tel: 0674-2598104, 2598105, 2598106, Fax: 0674-2598107, Guwahati: Tel: 0361-2134521, 2458923, Fax: 0361-2460355, Siliguri: Tel: 0353-2525907-3290402 (RIM), Jamshedpur: Tel: 0657-6542492, 09234369436, Patna: Tel: 0612-3244218, 2655519, Telefax: 0612-2655518

**WEST - REGIONAL OFFICE:** Mumbai: 302, Boston House, 3rd Floor Suren Road, CTS No. 260/261, Andheri (E) Mumbai-400093, Tel: 022-67298600-603, Ahmedabad: Tel: 079-40061111, 40060738-740, Fax: 079-40060741, Indore: Tel: 0731-2572340-41, 4009998 (Airtel), Fax: 0731-2551626, Rajkot: Tel: 0281-3013289/3013290, Nagpur: Tel: 0712-2224132, 2222692, 2222029, Pune: Tel: 020-64016413/14, Raipur: Tel: 0771-4243400 / 01, Telefax: 0771-4243402, Surat: Telefax: 0261-2350137

**SOUTH - REGIONAL OFFICE:** Chennai: Block – 1, A & D Wing, Shakthi Towers, 7th Floor, 766, Anna Salai, Chennai-600002, Tel: 044-28526941-44, Fax: 044-28524326, Bangalore: Tel: 080-49075000, Fax: 080-25582663, Coimbatore: Telefax: 0422-2305767, 2306199, 2305199, Hyderabad: Tel: 040-27533372, 27533355, 27533632, 66320407/0408/6401/6402, Fax: 040-27533211, Kochi: Tel: 0484-4099000, 2393165, 2393068, Fax: 0484-2393170, Vishakapatnam: Tel: 0891-6514339, Fax: 0891-2522547

Representative Offices :

• Goa • Solapur • Gwalior • Jabalpur • Hubli • Davanagere • Gulbarga • Mysore • Trichy • Kathmandu • Sambalpur • Jalandhar • Bhopal • Calicut • Madurai  
• Trivandrum • Vijayawada

**Havells India Ltd.**

Corp Office: QRG Towers, 2D, Sector-126, Expressway, Noida-201304 (U.P), Ph. +91-120-4771000,

Email: [marketing@havells.com](mailto:marketing@havells.com), [www.havells.com](http://www.havells.com)

Consumer Care No.: 1800 103 1313 (All Connections), 011-4166 0303 (Landline)

Join us on Facebook at [www.facebook.com/havells](http://www.facebook.com/havells) and share your ways to save the planet!

